

ESSENTIAL LINE



BLOCKBOARD CABINS • SYSTEM CABINS • GARAGES • ACCESSORIES

CONTENTS



LASITA MAJA	1	New York	57
Your garden cabin	2	Amarillo	57
About Lasita Maja	4		
Our colours	6		
SYSTEM CABINS	8	BLOCK CABINS WITH FLAT ROOF	58
Palermo	10	Belmont	60
Felix NEW!	12	Indi	61
Fynn NEW!	14	San Jose	61
Extensions for Felix + Fynn NEW!	16	Atlanta	62
Kibo	18	Sacramento	63
Zambezi	20	Amira	64
Zambezi XL	24	Augusta	65
Tuvalu	25		
STORAGE CABINS	26	BLOCK CABINS WITH FLAT ROOF AND COVERED AREA	66
Kent NEW!	28	Jelle Plus	68
Kent (Store cabins) NEW!	30	Long Beach	69
		New Orleans	70
		Novia Plus	70
		Tampa	71
		St. Paul	71
		St. Louis	72
		Reno	73
		Columbus	74
		Buffalo	75
BLOCK CABINS WITH GABLE ROOF	32	SPECIAL GARDEN CABINS	76
Ingo	34	Jura	77
Baltimore	35	Vilano	78
Norah	36		
Viljandi	37	GARAGES	80
Nina	38	Mauritius	82
Axel	38	Dillon	83
Dallas	39	Yarik	83
Washington	40		
Boston	40	ACCESSORIES	84
Udo	41	Doors	86
Norderney	42	Windows	88
Carroz	43	Accessories	90
Wels	44		
Lola	46	GOOD TO KNOW	94
Luna	47		
Riverside	48	CARE INSTRUCTIONS	95
Keila	49		
Robin	50	HOLIDAY HOMES	96
William	51		
BLOCK CABINS WITH GABLE ROOF AND COVERED AREA	52		
San Diego	54		
Kirian	54		
Wibo	54		
Ivana	56		
Kenzo	56		



OPTIMISED QUALITY – PROVEN PRODUCTS MADE EVEN BETTER

We have optimised the proven quality of our windows and doors. Please note the corresponding symbol for the respective cabins:

SILVER or BRONZE



SILVER

How you benefit

Windows:

- Single glazing 4 mm
- Window frame in double glued spruce, already pre-installed
- Window drip cap in wood
- Window openings inward
- Fittings pre-installed

Door:

- Door frame pre-installed
- Door frame in double glued spruce
- Including pre-installed screw-in hinges and milled locks
- Door incl. cylinder lock
- Door threshold on selected models in aluminium
- Code: SGC/MGC
- Roof boards 15 or 18 mm thick

BRONZE

How you benefit

Windows:

- Single glazing 4 mm
- Window frame in glued spruce, already pre-installed
- Window drip cap in wood
- Window openings inward
- Fittings not pre-installed

Door:

- Door frame not pre-installed
- Door frame in glued spruce
- Including pre-installed screw-on hinges and simple locks
- Door incl. cylinder lock
- Door threshold on selected models in aluminium
- Code: SGA
- Roof boards 15.5 mm thick



**SNAP &
WATCH**



**SNAP &
WATCH**

Lasita Maja.

MORE THAN 20 YEARS OF QUALITY

EVERY GARDEN CABIN BEGINS WITH A DREAM.

It's your dream. At Lasita Maja, we bring it to life.

As an experienced manufacturer of high-quality log cabins, we produce children's playhouses, pavilions, garages and individual holiday homes, as well as classic garden cabins. To do this, we use the best wood and combine modern and gentle processing technology with traditional craftsmanship and secure packaging. We are well aware that high quality equals happy customers. And if there's one thing that matters most, it's getting the details right.

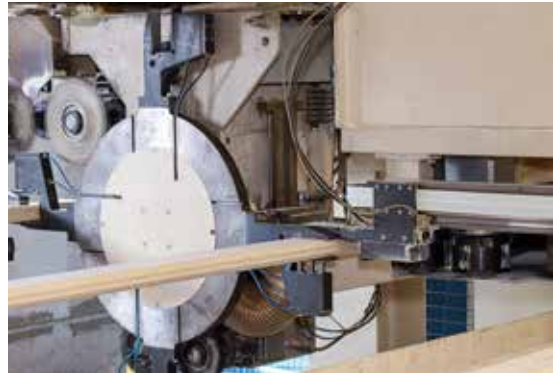

THE BEST QUALITY

We use only selected Nordic spruce for our garden cabins. Its flexible properties make it perfect for use as building and construction timber. Its slow growth in Europe's colder regions makes the wood particularly sturdy and solid. In general, wood is a sustainable, renewable raw material. As we place great value on environmentally responsible timber management, all our products in this catalogue are PEFC certified.



**SNAP &
LIKE**

FOLLOW US ON FACEBOOK.





OUR RECIPE FOR SUCCESS: HIGH-QUALITY NORDIC RAW MATERIALS, STATE-OF-THE-ART PROCESSING AND DECADES OF EXPERIENCE.

To ensure that we deliver a unique product, we rely on a combination of long-standing employees with a great deal of experience and modern machinery. Trained eyes inspect and sort the materials and components. Our precision machine tools saw, plane and mill the individual parts to the correct dimensions and shapes. Before being carefully and securely packed, everything undergoes a final inspection.

In order to be able to offer our customers the best quality, we have implemented a quality management system that complies with the requirements of the ISO 9001 standard. Our products also come with a 2-year or a 5-year warranty.



DELIVERED TO YOUR DOOR

The assembly kit

Your garden cabin will be delivered as a complete kit in one or more packs. Comprehensive assembly instructions are included. If you do not begin assembly immediately after delivery, store your garden cabin in a dry location, protected from UV light.

Delivery

We deliver our products to your specialist dealer on request or “to the kerb” at your home for an additional charge. Delivery will be made on the agreed date using a 40 t HGV. There must be no restrictions to access for this vehicle.

Presenting:

THE HIGH-END PAINT SYSTEM FOR GARDEN CABINS MADE IN ESTONIA.



The environmentally friendly water-based stain is ideal for professional use outdoors and provides lasting protection for your garden cabin.

ALMOST ALL CABINS IN 4 COLOURS. NO UNDERCOAT REQUIRED!



Light Grey



Carbon Grey



NEW!

New - Green-grey



Swedish Red

Our 4 colours

Wooden doors, windows and cover strips are always supplied in a timeless cream white, which in combination with the main colours results in four attractive variants. In addition, we offer a water-based glaze - a reliable and long-lasting protection that is ideal for professional outdoor use. Please note that the colours shown may differ slightly from the actual finish, as printing inks affect colour reproduction and therefore slight differences may occur.

At a glance

- Garden cabin delivered as standard with a natural finish
- Environmentally friendly and low-odour treatment
- Ideal protection against weather, fungi, insect infestation, mildew and blue stain
- Paint for repairing minor damage included in delivery
- Recommended maintenance interval 5 years (depending on location, compass direction and colour), Lasita Maja warranty max. 5 years**.
- Slight colour differences are possible due to the nature of the wood.

The advantages of our wood treatment

- No undercoat required.
- 3-sided colour treatment of the wall boards
- Natural finish on the interior, creating a natural feeling of wellbeing inside
- Unique six-sided colour treatment of the log corner joints and log heads
- Natural roof purlins and roof boards

**Find out more about our warranty conditions in the installation instructions or at www.lasita.com.

REVERSE INSTALLATION

Please note that reverse installation of coloured garden cabins is not possible due to the one-sided colour finish!

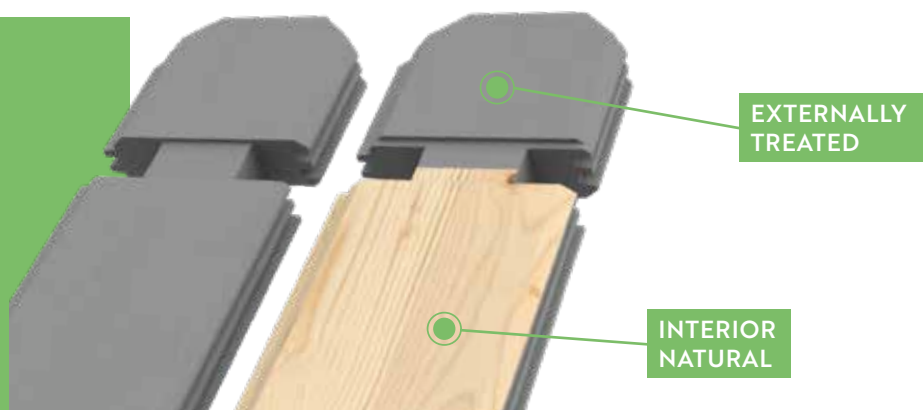

EXTERNALLY TREATED

INTERIOR NATURAL

SYSTEM CABINS.

MODERN, HIGH-QUALITY, STYLISH:
MORE THAN JUST A STOREROOM.

05

MODELS





**NOW AVAILABLE
IN SIZE 4!**



PALERMO SILVER

LARGE WINDOWS PROVIDE LOTS OF LIGHT AND DIRECT CONTACT WITH NATURE.

	PALERMO 1	PALERMO 2	PALERMO 3	PALERMO 4
Item number	2853400	2853500	2844519	2864000
Base dimensions W x D	300 x 300 cm	450 x 300 cm	300 x 300 cm	400 x 300
Wall thickness	28 mm	28 mm	28 mm	28 mm
Floor area	8.67 m ²	13.08 m ²	8.67 m ²	11.61 m ²
Capacity	19.27 m ³	29.08 m ³	20.75 m ³	26.47 m ³
Side wall height	222 cm	222 cm	239 cm	228 cm
Ridge height	222 cm	222 cm	239 cm	228 cm
Roof area	8.90 m ²	13.32 m ²	8.90 m ²	12.10 m ²
Glazed door W x H	149.4 x 185 cm	265.8 x 185 cm	2 x 204.1 x 202.6 cm	149.4 x 185 cm
Window size W x H	56 x 178 cm	56 x 178 cm	-	2 x 56 x 167.4 cm
Floor, included	15.5 mm	15.5 mm	15.5 mm	15.5 mm
Onduline, optional	3 x	3 x	3 x	3 x

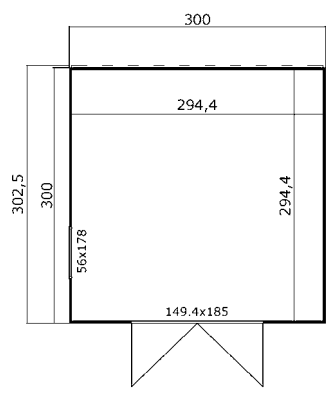

PALERMO 1

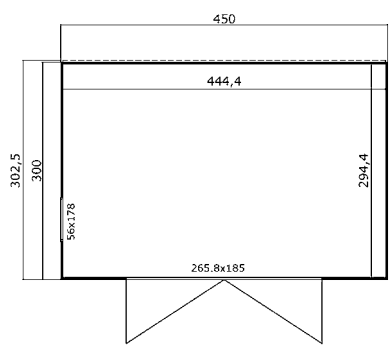

PALERMO 2

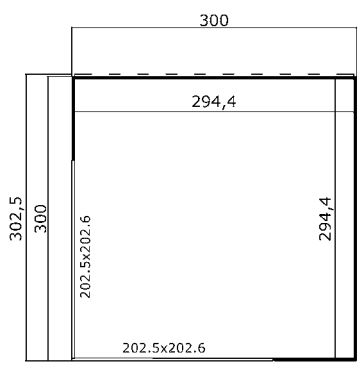

PALERMO 3

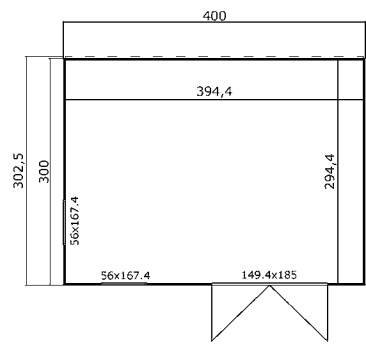

PALERMO 4

NEW!



3.8 m² Felix 1

FELIX SILVER

NEW!

YOUR SPACE FOR IDEAS – A PROVEN CONCEPT WITH A FRESH DESIGN

	FELIX 1	FELIX 1,5	FELIX 2	FELIX 3
Item number	2859394	2863294	2859494	2859594
Base dimensions W × D	200 × 200 cm	250 × 200 cm	250 × 250 cm	300 × 300 cm
Wall thickness	28 mm	28 mm	28 mm	28 mm
Floor area	3.78 m ²	4.75 m ²	5.97 m ²	8.67 m ²
Capacity	8.4 m ³	10.56 m ³	13.28 m ³	19.27 m ³
Side wall height	222 cm	222 cm	222 cm	222 cm
Ridge height	222 cm	222 cm	222 cm	222 cm
Roof area	4.15 m ²	5 m ²	6.57 m ²	9.22 m ²
Glazed door W x H	149.4 × 185 cm	149.4 × 185 cm	149.4 × 185 cm	149.4 × 185 cm
Floor, optional	200 × 200 cm <i>Item 2863599</i>	250 × 200 cm <i>Item 2863899</i>	250 × 250 cm <i>Item 2863699</i>	300 × 300 cm <i>Item 2863799</i>
Roofing felt, optional	1 × 15 m	1 × 15 m	1 × 15 m	1 × 15 m
Onduline, optional	1 ×	1 ×	2 ×	2 ×

APPROPRIATE ACCESSORIES



window
available in different colours



Flooring

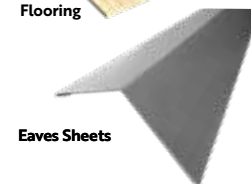

Eaves Sheets

Other accessories
can be found from page 84.



87m² Felix 3

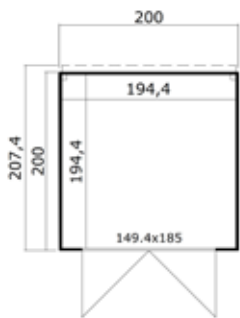

FELIX 1

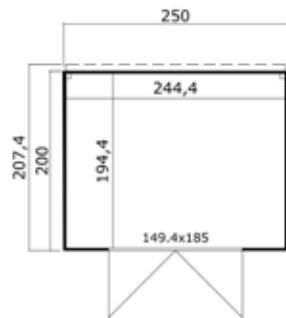

FELIX 1,5

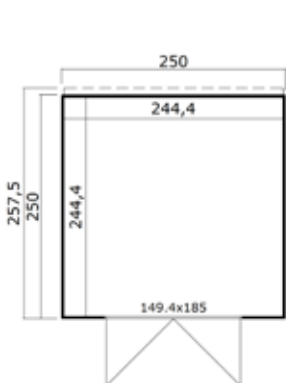

FELIX 2

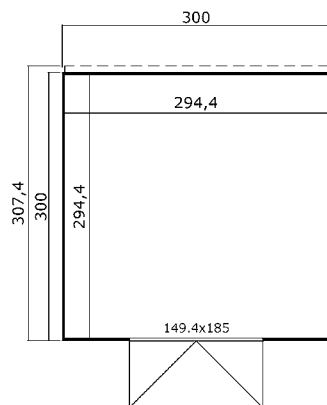

FELIX 3

APPROPRIATE ACCESSORIES



Extension for Felix + Fynn

Other accessories can be found from page 84.

NEW!



3.8 m²

Fynn 1



NEW!

8.7 m²

Fynn 3



	FYNN 1	FYNN 1,5	FYNN 2	FYNN 3
Item number	2859694	2863494	2859794	2859894
Base dimensions W × D	200 × 200 cm	250 × 200 cm	250 × 250 cm	300 × 300 cm
Wall thickness	28 mm	28 mm	28 mm	28 mm
Floor area	3.78 m ²	4.75 m ²	5.97 m ²	8.67 m ²
Capacity	8.4 m ³	10.56 m ³	13.28 m ³	19.27 m ³
Side wall height	222 cm	222 cm	222 cm	222 cm
Ridge height	222 cm	222 cm	222 cm	222 cm
Roof area	4.15 m ²	5 m ²	6.57 m ²	9.22 m ²
Glazed door W x H	149.4 × 185 cm	149.4 × 185 cm	149.4 × 185 cm	149.4 × 185 cm
Floor, optional	200 × 200 cm <i>Item 2863599</i>	250 × 200 cm <i>Item 2863899</i>	250 × 250 cm <i>Item 2863699</i>	300 × 300 cm <i>Item 2863799</i>
Roofing felt, optional	1 × 15 m	1 × 15 m	1 × 15 m	1 × 15 m
Onduline, optional	1 ×	1 ×	2 ×	2 ×

APPROPRIATE ACCESSORIES



window
available in different colours



Flooring

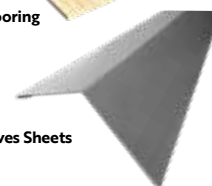

Eaves Sheets

Other accessories
can be found from page 84.

NEW!



FYNN SILVER

VERSATILE USE - PRACTICAL TOOL SHED OR COSY HOBBY ROOM

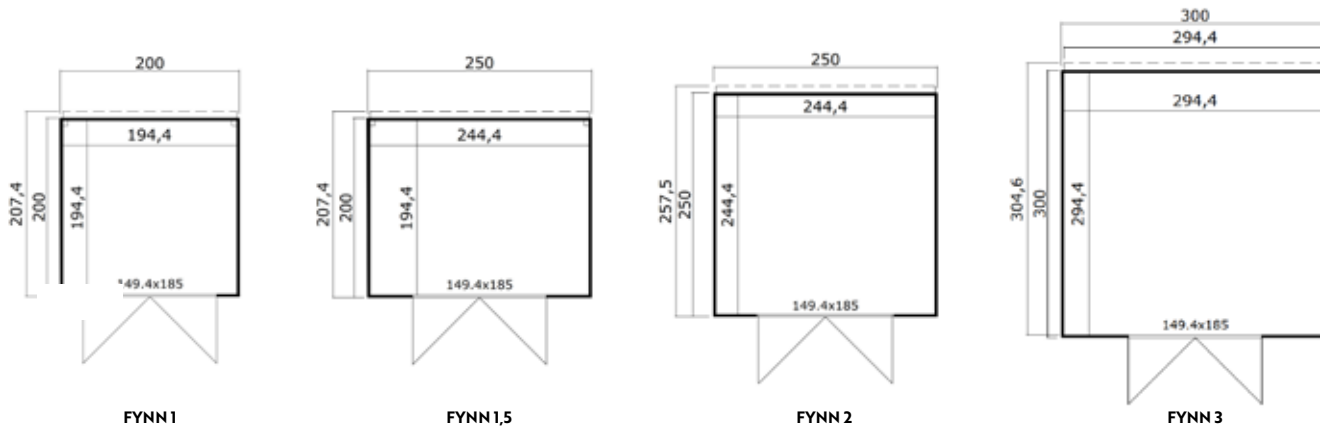

NEW!



9.5 m²

Felix 1 + Extension 300 × 200

EXTENSIONS / FELIX + FYNN SILVER

YOUR NEXT STEP: A PRACTICAL EXTENSION FOR EVEN MORE STORAGE SPACE OR CREATIVITY.

	EXTENSION 150 × 200	EXTENSION 150 × 250	EXTENSION 150 × 300	EXTENSION 300 × 200	EXTENSION 300 × 250	EXTENSION 300 × 300
Item number	9915600	9915700	9915800	9915300	9915400	9915500
Base dimensions W × D	150 × 200 cm	150 × 250 cm	150 × 300 cm	300 × 200 cm	300 × 250 cm	300 × 300 cm
Wall thickness	28 mm	28 mm	28 mm	28 mm	28 mm	28 mm
Floor area	2.81 m ²	3.53 m ²	4.25 m ²	5.72 m ²	7.2 m ²	8.67 m ²
Capacity	6.24 m ³	7.85 m ³	9.45 m ³	12.72 m ³	15.99 m ³	19.27 m ³
Side wall height	222 cm	222 cm	222 cm	222 cm	222 cm	222 cm
Ridge height	222 cm	222 cm	222 cm	222 cm	222 cm	222 cm
Roof area	3.11 m ²	3.86 m ²	9.38 m ²	6.22 m ²	7.72 m ²	9.38 m ²
Roofing felt, optional	1 × 15 m	1 × 15 m	1 × 15 m	1 × 15 m	1 × 15 m	1 × 15 m
Onduline, optional	1 ×	1 ×	2 ×	2 ×	2 ×	2 ×

NEW!



Fynn 3 + Extension 150 × 300

12.9 m²



Felix 2 + Extension 150 × 250

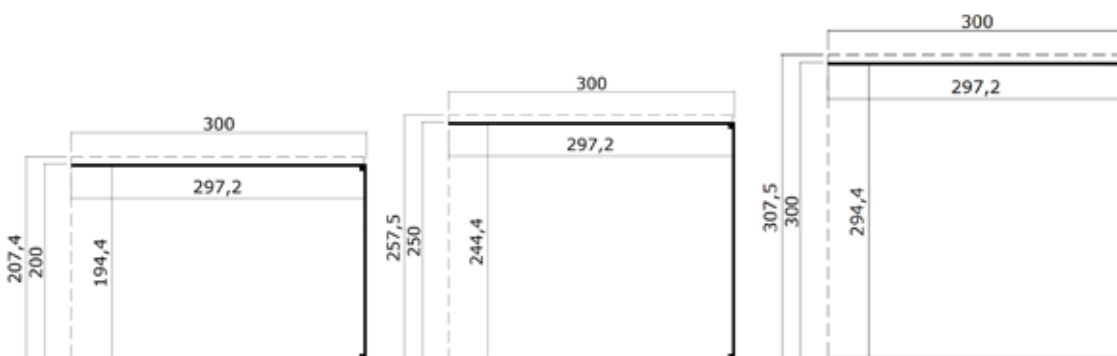
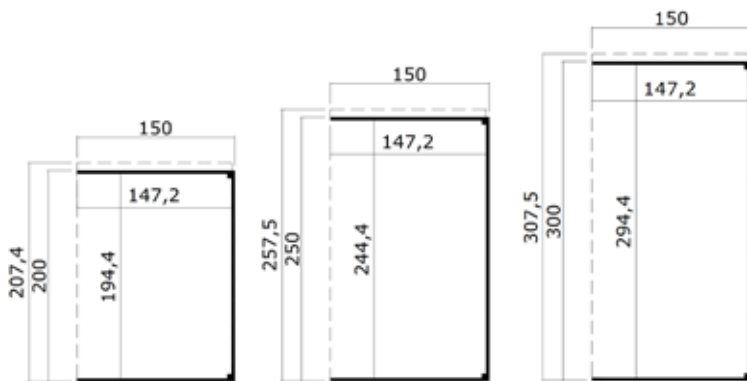

APPROPRIATE ACCESSORIES



Premium roofing felt

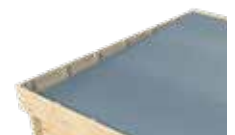

Onduline

Other accessories can be found from page 84.



KIBO BRONZE

STYLISH CABIN WITH SKYLIGHT: PERFECT AS A STOREROOM OR WORKSHOP.



	KIBO 1	KIBO 2	KIBO 3
Item number	2851296	2851396	2851496
Base dimensions W x D	200 x 200 cm	200 x 250 cm	250 x 250 cm
Wall thickness	28 mm	28 mm	28 mm
Floor area	3.78 m ²	4.75 m ²	5.97 m ²
Capacity	8.83 m ³	11.10 m ³	13.96 m ³
Side wall height	222 cm	222 cm	222 cm
Ridge height	245 cm	245 cm	245 cm
Roof overhang	10 cm	10 cm	10 cm
Roof area	5.10 m ²	6.20 m ²	7.40 m ²
Glazed door W x H	149 x 185 cm	149 x 185 cm	149 x 185 cm
Fixed window W x H	245 x 34 cm	245 x 34 cm	245 x 34 cm
Floor, optional	1 x 3 / 1 x 1.5 m ²	2 x 3 m ²	2 x 3 / 1 x 1.5 m ²
Roofing felt, optional	1 x 15 m	1 x 15 m	1 x 15 m
Onduline, optional	2 x	2 x	3 x

APPROPRIATE ACCESSORIES



Premium roofing felt

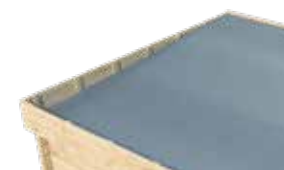

Onduline

Other accessories
can be found from page 84.

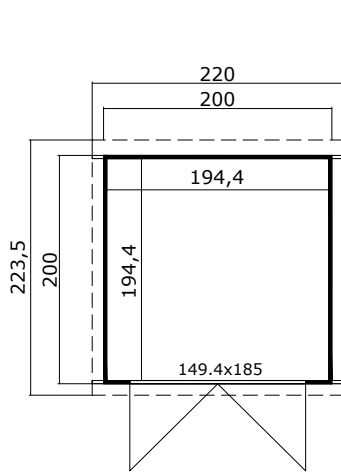

KIBO 1

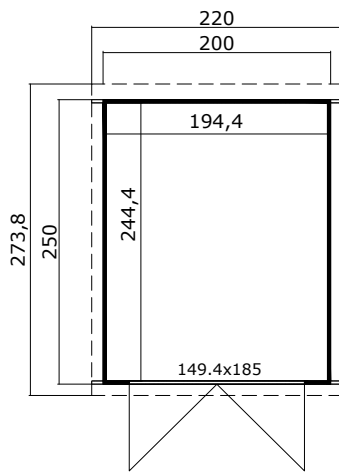

KIBO 2

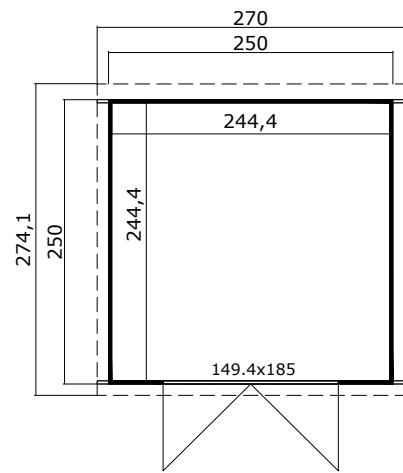

KIBO 3

Large double door with satin-finished Plexiglas® (28 mm frame)



8.7 m² Zambezi 1

ZAMBEZI BRONZE

SMART STOREROOM FOR ALL GARDEN EQUIPMENT.

	ZAMBEZI 1	ZAMBEZI 2	ZAMBEZI 3	ZAMBEZI 4
Item number	2846096	2846196	2846296	2846396
Base dimensions W x D	200 x 200 cm	200 x 250 cm	250 x 200 cm	250 x 250 cm
Wall thickness	28 mm	28 mm	28 mm	28 mm
Floor area	3.78 m ²	4.75 m ²	4.75 m ²	5.97 m ²
Capacity	7.75 m ³	9.75 m ³	9.75 m ³	12.26 m ³
Side wall height	200 cm	200 cm	200 cm	200 cm
Ridge height	211 cm	211 cm	211 cm	211 cm
Roof overhang	10 cm	10 cm	10 cm	10 cm
Roof area	4.95 m ²	6.05 m ²	6.08 m ²	7.43 m ²
Double door W x H	149 x 185 cm	149 x 185 cm	149 x 185 cm	149 x 185 cm
Floor, optional	1 x 3 / 1 x 1.5 m ²	2 x 3 m ²	2 x 3 m ²	2 x 3 m ² / 1 x 1.5 m ²
Roofing felt, optional	1 x 10 m	1 x 10 m	1 x 10 m	1 x 10 m
Onduline, optional	2 x	2 x	3 x	3 x

APPROPRIATE ACCESSORIES



Premium roofing felt

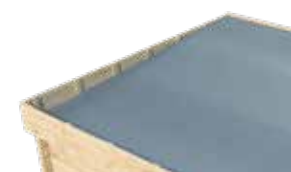

Onduline

Other accessories can be found from page 84.



Zambezi 3



Zambezi 4



Zambezi 2

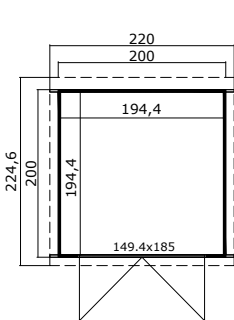

ZAMBEZI 1

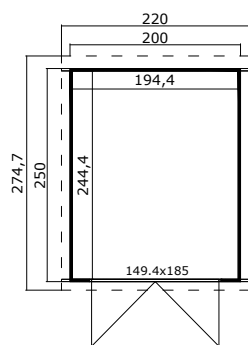

ZAMBEZI 2

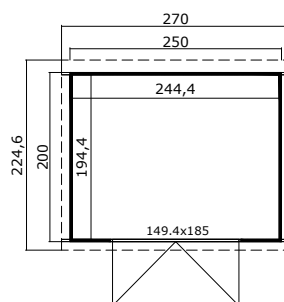

ZAMBEZI 3

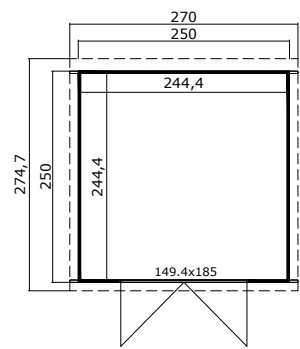

ZAMBEZI 4



Large double door with satin-finished Plexiglas® (28 mm frame)

Modern corner joints

8.7 m² Zambezi 7

ZAMBEZI BRONZE

SMART STOREROOM FOR ALL GARDEN EQUIPMENT.

	ZAMBEZI 5	ZAMBEZI 6	ZAMBEZI 7
Item number	2846496	2847096	2847196
Base dimensions W x D	250 x 300 cm	300 x 250 cm	300 x 300 cm
Wall thickness	28 mm	28 mm	28 mm
Floor area	7.20 m ²	7.20 m ²	8.67 m ²
Capacity	14.76 m ³	14.76 m ³	17.78 m ³
Side wall height	200 cm	200 cm	200 cm
Ridge height	211 cm	211 cm	211 cm
Roof overhang	10 cm	10 cm	10 cm
Roof area	8.78 m ²	8.80 m ²	10.40 m ²
Double door W x H	149 x 185 cm	149 x 185 cm	149 x 185 cm
Floor, optional	2 x 3 / 1 x 1.5 m ²	2 x 3 / 1 x 1.5 m ²	3 x 3 m ²
Roofing felt, optional	1 x 15 m	1 x 15 m	1 x 15 m
Onduline, optional	4 x	3 x	4 x

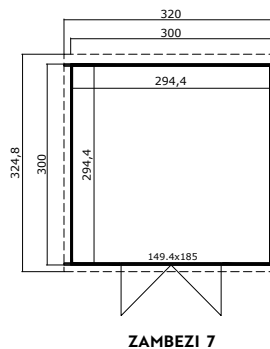
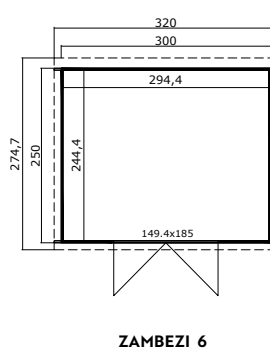
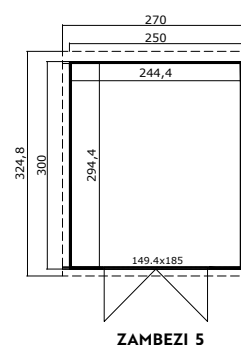



Zambezi 1 + Extension 1



Extension 2



Extension 3

	ZAMBEZI EXTENSION 1	ZAMBEZI EXTENSION 2	ZAMBEZI EXTENSION 3
Item number	9906000	9906100	9906200
Base dimensions W × D	250 × 200 cm	250 × 250 cm	250 × 300 cm
Wall thickness	28 mm	28 mm	28 mm
Floor area	4.75 m ²	5.97 m ²	7.20 m ²
Capacity	9.75 m ³	12.26 m ³	14.76 m ³
Side wall height	200 cm	200 cm	200 cm
Ridge height	211 cm	211 cm	211 cm
Roof overhang	10 cm	10 cm	10 cm
Roof area	5.80 m ²	7.10 m ²	8.40 m ²
Roofing felt, optional	1 × 10 m	1 × 10 m	1 × 10 m
Onduline, optional	3 ×	3 ×	4 ×

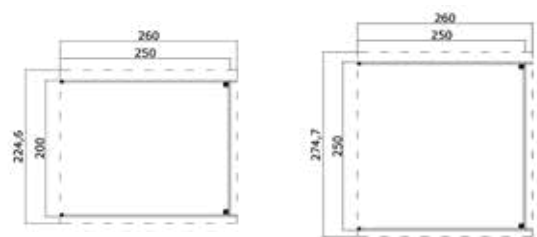

EXTENSION 1

EXTENSION 2

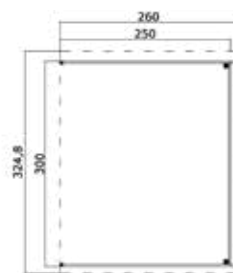

EXTENSION 3



8.8 m² Zambezi XL

ZAMBEZI XL BRONZE

BEAUTIFUL CABIN WITH TWO ROOMS, PERFECT FOR PLAYING AND LIVING.



	ZAMBEZI XL
Item number	2851696
Base dimensions W × D	380 × 240
Wall thickness	28 mm
Floor area	8.78 m ²
Capacity	18.01 m ³
Side wall height	200 cm
Ridge height	211 cm
Roof overhang	10 cm
Roof area	10.53 m ²
Glazed double door W × H	149 × 185 cm
Glazed single door W × H	149 × 185 cm
Floor, optional	3 × 3 m ² / 1 × 1.5 m ²
Roofing felt, optional	1 × 15 m
Onduline, optional	3 ×

APPROPRIATE ACCESSORIES



Premium roofing felt

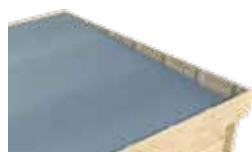

Onduline

Other accessories
can be found from page 84.

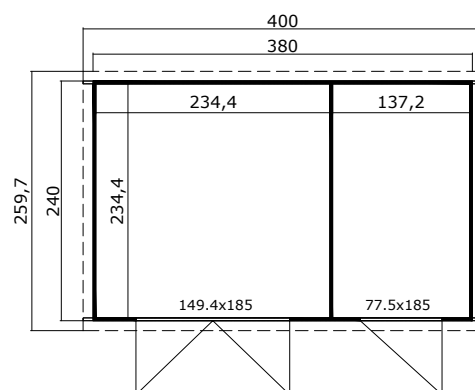



TUVALU BRONZE

SPACIOUS GARDEN CABIN WITH TWO STORAGE SPACES.



	TUVALU XL
Item number	2848500
Base dimensions W x D	500 x 300 cm
Wall thickness	28 mm
Floor area	14.56 m ²
Capacity	33.60 m ³
Side wall height	211 cm
Ridge height	251 cm
Roof overhang	15.60 cm
Roof area	18.40 m ²
Double door W x H	149 x 185 cm
Single door W x H	78 x 185 cm
Floor, included	15,5 mm
Roofing felt, optional	2 x 15 m
Roof shingles, optional (pack)	8 x

APPROPRIATE ACCESSORIES

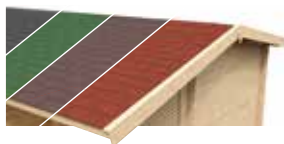

Roof shingles
in various colours



Gutter

Other accessories
can be found from page 84.

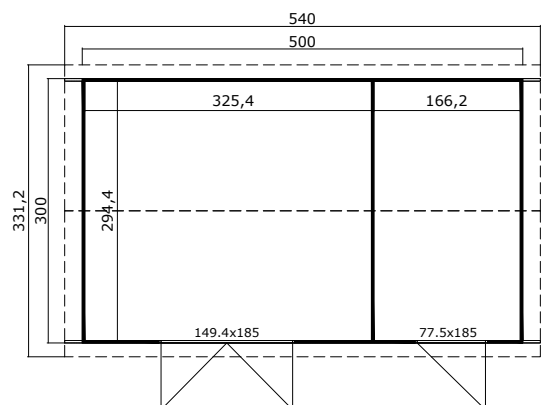

STORAGE CABINS.

PLENTY OF SPACE FOR TOOLS, APPLIANCES
AND MORE - INTELLIGENT STORAGE SPACE FOR
THE GARDEN, EVERYDAY LIFE OR BUSINESS.

08

MODELS





NEW!



Kent 1.1



Kent 2.1

KENT BRONZE

BRIGHT CABIN, PERFECT AS A WORKROOM.

	KENT 1.1	KENT 2.1	KENT 3.1
Item number	E130300	E130800	E130500
Base dimensions W × D	170 × 67 cm	170 × 120 cm	170 × 175 cm
Wall thickness	13 mm	13 mm	13 mm
Floor area	1.08 m ²	1.97 m ²	2.89 m ²
Capacity	2.11 m ³	3.86 m ³	5.61 m ³
Side wall height	175 cm	177 cm	174 cm
Ridge height	2.17 cm	2.17 cm	2.13 cm
Roof overhang	10 cm	10 cm	10 cm
Roof area	1.76 m ²	2.44 m ²	4.1 m ²
Double door W x H	115.2 × 177 cm	115.2 × 177 cm	115.2 × 177 cm
Floor included	15.5 mm	15.5 mm	15.5 mm
Roofing felt, optional	1 × 10 m	1 × 10 m	1 × 10 m
Roof shingles, optional (pack)	1 ×	2 ×	2 ×

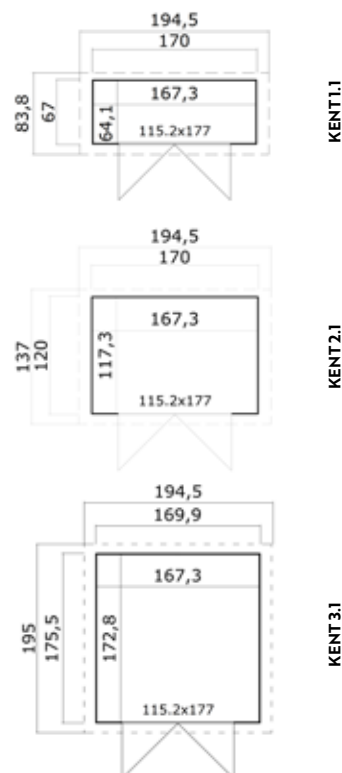

NEW!



2 m²

Kent 2.2

Kent 3.2

	KENT 1.2	KENT 2.2	KENT 3.2
Item number	E130700	E130900	E130600
Base dimensions W x D	170 x 67 cm	170 x 120 cm	170 x 175 cm
Wall thickness	13 mm	13 mm	13 mm
Floor area	1.07 m ²	1.97 m ²	2.9 m ²
Capacity	2.12 m ³	3.77 m ³	5.56 m ³
Side wall height	194 cm	185 cm	1.85 cm
Ridge height	200 cm	199 cm	199 cm
Roof overhang	6 cm	7 cm	7 cm
Roof area	1.47 m ²	2.44 m ²	3.59 m ²
Double door W x H	115.2 x 177 cm	115.2 x 177 cm	115.2 x 177 cm
Floor included	15.5 mm	15.5 mm	15.5 mm
Roofing felt, optional	1 x 10 m	1 x 10 m	1 x 10 m
Onduline, optional	1 x	1 x	1 x



APPROPRIATE ACCESSORIES

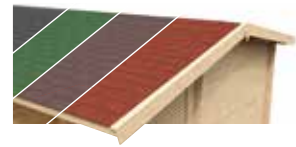

Roof shingles
in various colours



Gutter

Other accessories can be found from page 84.

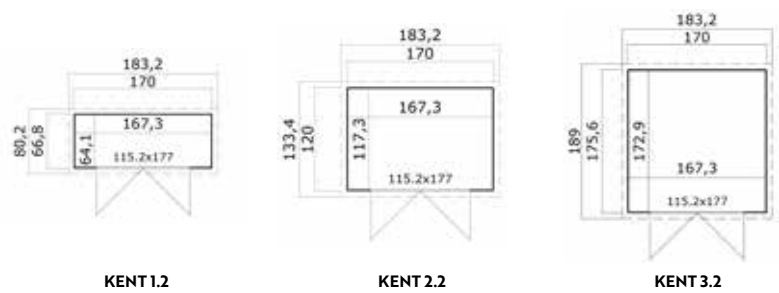



2.9 m²

Kent 4

KENT 4 BRONZE

COMPACT SIZE, STURDY SALES SPACE – YOUR PRACTICAL SALES CABIN.

	KENT 4
Item number	E131000
Base dimensions W x D	170 x 176 cm
Wall thickness	13 mm
Floor area	2.89 m ²
Capacity	5.56 m ³
Side wall height	1.74 cm
Ridge height	210 cm
Roof overhang	10 cm
Roof area	4.72 m ²
Single door W x H	90.8 x 175.4 cm
Floor included	15.5 mm
Roofing felt, optional	1 x 15 m
Roof shingles, optional (pack)	2 x

APPROPRIATE ACCESSORIES

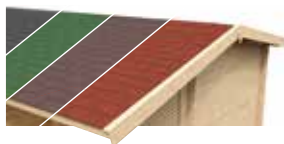

Roof shingles
in various colours



Gutter

Other accessories
can be found from page 84.

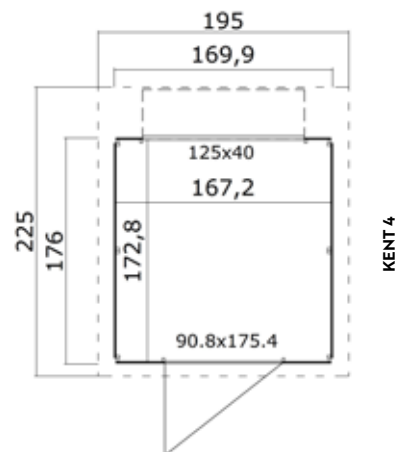



5.83 m² Kent 5

KENT 5 BRONZE

MORE SPACE, MORE SUCCESS – WITH A SPACIOUS REAR ENTRANCE.

	KENT 5
Item number	E180200
Base dimensions W x D	170 x 176 cm
Wall thickness	13 mm
Floor area	5.83 m ²
Capacity	12.1 m ³
Side wall height	1.87 m
Ridge height	228 cm
Roof overhang	40 cm
Roof area	8.25 m ²
Single door W x H	107.8 x 181.8 cm
Floor included	15.5 mm
Roofing felt, optional	1 x 15 m
Roof shingles, optional (pack)	2 x

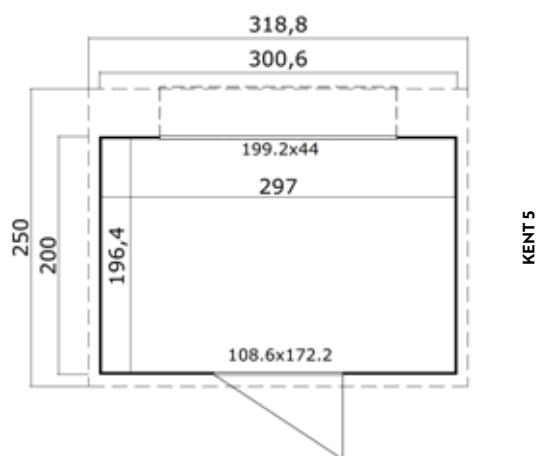

BLOCK CABINS WITH GABLE ROOF.

RETHINKING A CLASSIC LOOK.
SOLID,
MODERN,
ATTRACTIVE,
ROMANTIC.

19

MODELS







INGO BRONZE

WITH WIDE DOOR FOR BULKY EQUIPMENT.



	INGO 175	INGO 230
Item number	2833896	2833996
Base dimensions W x D	230 x 175 cm	230 x 230 cm
Wall thickness	28 mm	28 mm
Floor area	3.80 m ²	5.04 m ²
Capacity	7.91 m ³	10.48 m ³
Side wall height	194 cm	194 cm
Ridge height	222 cm	222 cm
Roof overhang	10 cm	10 cm
Roof area	5.26 m ²	6.75 m ²
Double door W x H	149 x 185 cm	149 x 185 cm
Floor, optional	2 x 3 m ²	2 x 3 m ²
Roofing felt, optional	1 x 10 m	1 x 10 m
Roof shingles, optional (pack)	3 x	3 x

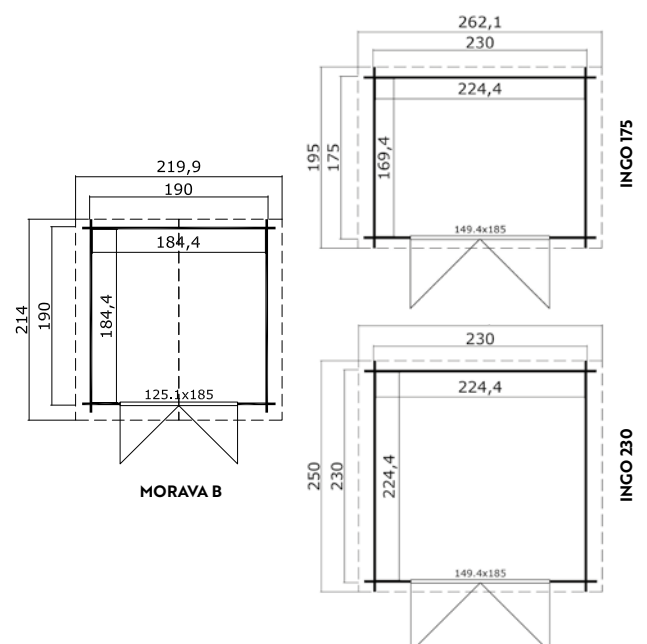



BALTIMORE BRONZE

COMPACT FOR SMALL SITES.



BALTIMORE

Item number	2825196
Base dimensions W x D	292 x 230 cm
Wall thickness	28 mm
Floor area	6,43 m ²
Capacity	13,37 m ³
Side wall height	194 cm
Ridge height	222 cm
Roof overhang	50 cm
Roof area	9,57 m ²
Double door W x H	149 x 185 cm
Floor, optional	2 x 3 / 1 x 1,5 m ²
Roofing felt, optional	1 x 15 m
Roof shingles, optional (pack)	4 x

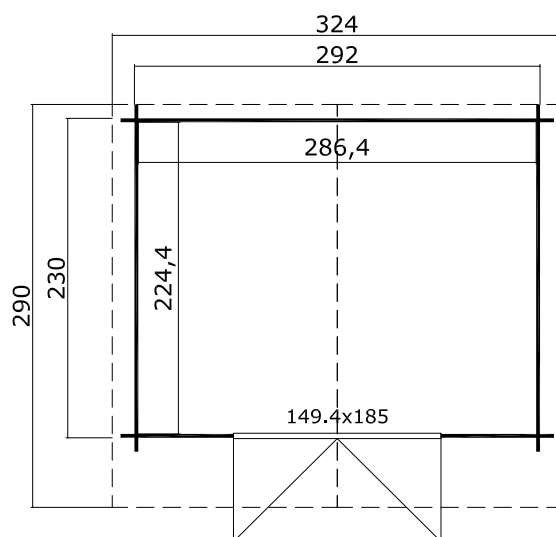



7.3 m²

Norah 275



Norah 230

NORAH BRONZE

ENOUGH SPACE FOR ALL THE TOYS..



	NORAH 230	NORAH 275	NORAH 380
Item number	2835096	2835196	2850596
Base dimensions W x D	275 x 230 cm	275 x 275 cm	275 x 380 cm
Wall thickness	28 mm	28 mm	28 mm
Floor area	6,05 m ²	7,26 m ²	10,09 m ²
Capacity	12,92 m ³	15,51 m ³	21,56 m ³
Side wall height	194 cm	194 cm	194 cm
Ridge height	234 cm	234 cm	234 cm
Roof overhang	10 cm	10 cm	10 cm
Roof area	8,00 m ²	9,44 m ²	12,08 m ²
Double door W x H	149 x 185 cm	149 x 185 cm	149 x 185 cm
Floor, optional	2 x 3 m ²	3 x 3 m ²	3 x 3 m ²
Roofing felt, optional	1 x 15 m	1 x 15 m	2 x 10 m
Roof shingles, optional (pack)	4 x	7 x	5 x

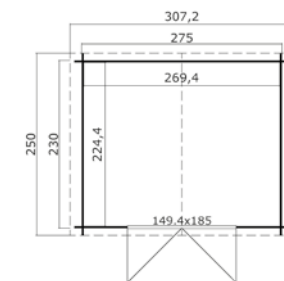

NORAH 230

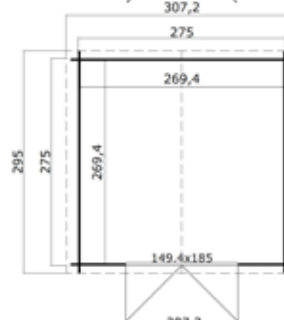

NORAH 275



NORAH 380



VILJANDI BRONZE

LARGE CANOPY FOR A COSY OUTDOOR SEATING AREA.



	VILJANDI 34
Item number	3420296
Base dimensions W x D	300 x 300 cm
Wall thickness	34 mm
Floor area	8,46 m ²
Capacity	18,87 m ³
Side wall height	194 cm
Ridge height	245 cm
Roof overhang	125 cm
Roof area	16,20 m ²
Double door W x H	149 x 185 cm
Floor, optional	3 x 3 m ²
Roofing felt, optional	2 x 10 m
Roof shingles, optional (pack)	7 x

APPROPRIATE ACCESSORIES

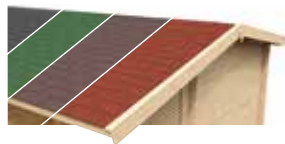

Roof shingles
in various colours



Gutter

Other accessories
can be found from page 84.

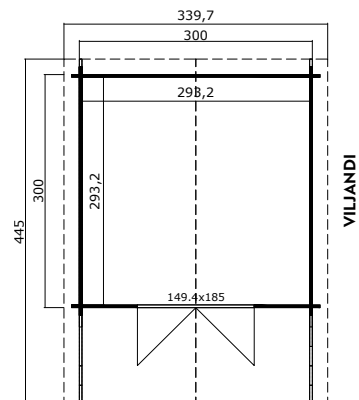



4.6 m² Nina 175

NINA, AXEL BRONZE

PLENTY OF LIGHT AND WIDE DOORS FOR A SPACIOUS WORKSHOP.

	NINA 175	NINA 230	NINA 275	AXEL 230
Item number	2834496	2834596	2834696	2837296
Base dimensions W × D	275 × 175 cm	275 × 230 cm	275 × 275 cm	380 × 230 cm
Wall thickness	28 mm	28 mm	28 mm	28 mm
Floor area	4.56 m ²	6.05 m ²	7.26 m ²	8.40 m ²
Capacity	9.75 m ³	12.92 m ³	15.51 m ³	18.44 m ³
Side wall height	194 cm	194 cm	194 cm	194 cm
Ridge height	234 cm	234 cm	234 cm	245 cm
Roof overhang	10 cm	10 cm	10 cm	10 cm
Roof area	6.24 m ²	8 m ²	9.44 m ²	10.75 m ²
Single door W x H	78 × 185 cm	78 × 185 cm	78 × 185 cm	149 × 185 cm
Window size W x H	69 × 88 cm	69 × 88 cm	69 × 88 cm	129 × 88 cm
Floor, optional	2 × 3 m ²	2 × 3 / 1 × 1,5 m ²	2 × 3 / 1 × 1,5 m ²	3 × 3 m ²
Roofing felt, optional	1 × 10 m	1 × 10 m	1 × 15 m	1 × 15 m
Roof shingles, optional (pack)	3 ×	4 ×	4 ×	5 ×

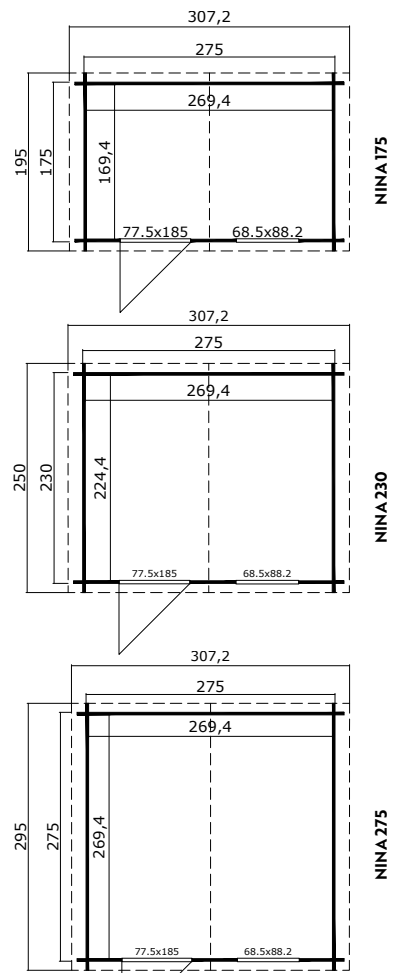



10.6m² Dallas

DALLAS BRONZE

LARGE GLASS SURFACES ENSURE OPENNESS.



	DALLAS
Item number	2825396
Base dimensions W x D	376 x 292 cm
Wall thickness	28 mm
Floor area	10.61 m ²
Capacity	22,63 m ³
Side wall height	194 cm
Ridge height	234 cm
Roof overhang	10 cm
Roof area	13.1 m ²
Double door W x H	149 x 185 cm
2 x Single window W x H	69 x 88 cm
Floor, optional	4 x 3 m ²
Roofing felt, optional	2 x 10 m
Roof shingles, optional (pack)	6 x

APPROPRIATE ACCESSORIES

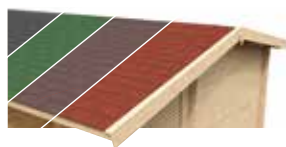

Roof shingles in various colours



Gutter

Other accessories can be found from page 84.

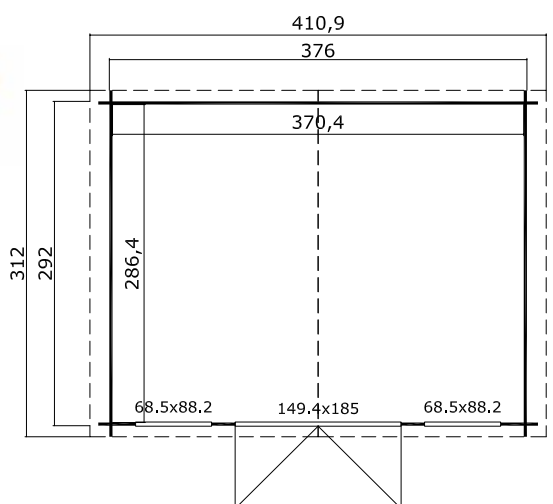

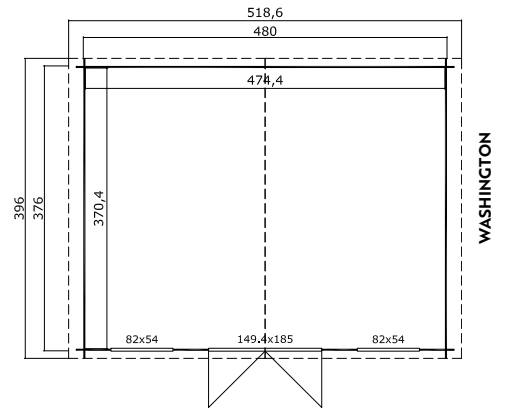

17.6 m² Washington



WASHINGTON BRONZE
BOSTON BRONZE
PERFECT
STUDIO FOR
THE GARDEN.

13.6 m² Boston



	WASHINGTON	BOSTON
Item number	2825596	2825496
Base dimensions W x D	480 x 376 cm	480 x 292 cm
Wall thickness	28 mm	28 mm
Floor area	17.57 m ²	13.59 m ²
Capacity	38.56 m ³	29.82 m ³
Side wall height	194 cm	194 cm
Ridge height	245 cm	245 cm
Roof overhang	10 cm	10 cm
Roof area	20.99 m ²	16.54 m ²
Double door W x H	149 x 185 cm	149 x 185 cm
2 x single window W x H	82 x 54 cm	82 x 54 cm
Floor, optional	6 x 3 m ²	5 x 3 m ²
Roofing felt, optional	2 x 15 m	2 x 10 m
Roof shingles, optional (pack)	8 x	7 x

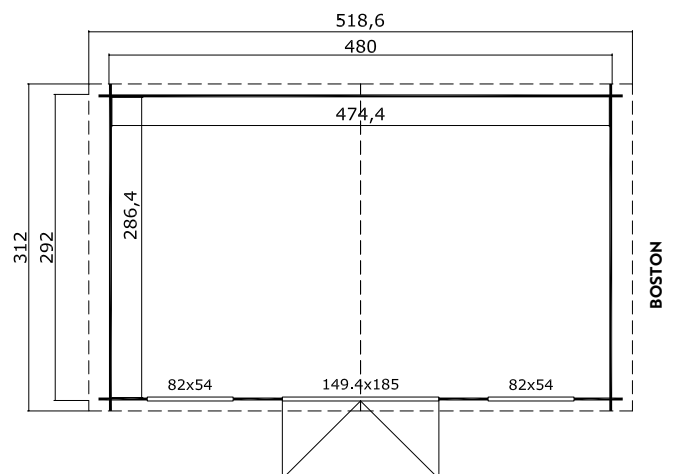



17.8 m²

Udo 380



Udo 300

UDO BRONZE

LARGE, COSY GARDEN CABIN.



	UDO 300	UDO 380
Item number	2841196	2841296
Base dimensions W x D	480 x 300 cm	480 x 380 cm
Wall thickness	28 mm	28 mm
Floor area	13.97 m ²	17.76 m ²
Capacity	31.45 m ³	39.99 m ³
Side wall height	194 cm	194 cm
Ridge height	257 cm	257 cm
Roof overhang	10 cm	10 cm
Roof area	17.28 m ²	21.60 m ²
Double door W x H	149 x 185 cm	149 x 185 cm
2 x single window W x H	2 x 69 x 88 cm	2 x 69 x 88 cm
Floor, optional	5 x 3 m ²	6 x 3 m ²
Roofing felt, optional	2 x 10 m	3 x 10 m
Roof shingles, optional (pack)	7 x	9 x

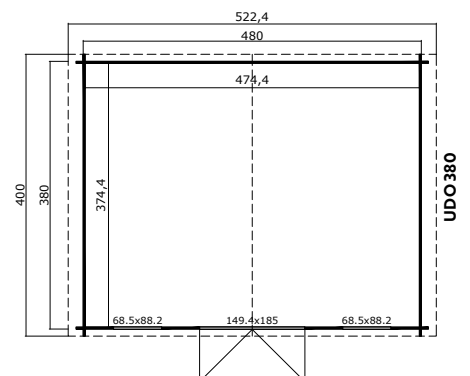
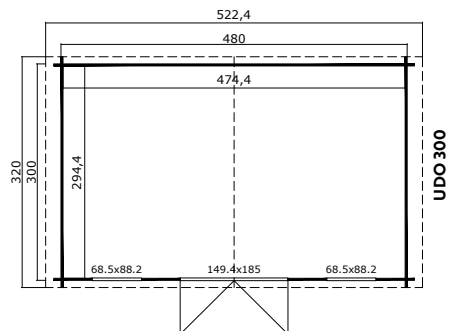



Available in two depths

Large Roof overhang

11.2 m²

Norderney 2



Norderney 3

NORDERNEY SILVER

STYLISH CLASSIC WITH PLENTY OF LIVING ROOM.



	NORDERNEY 2	NORDERNEY 3
Item number	401900	402000
Base dimensions W x D	390 x 300 cm	390 x 390 cm
Wall thickness	40 mm	40 mm
Floor area	11.20 m ²	14.60 m ²
Capacity	25.70 m ³	33.70 m ³
Side wall height	205 cm	205 cm
Ridge height	256 cm	256 cm
Roof overhang	70 cm	70 cm
Roof area	17.90 m ²	22.10 m ²
Double door W x H	149 x 196 cm	149 x 196 cm
2 x double window W x H	129 x 88 cm	129 x 88 cm
Floor, included	18.5 mm	18.5 mm
Roofing felt, optional	2 x 15 m	2 x 15 m
Roof shingles, optional (pack)	7 x	9 x

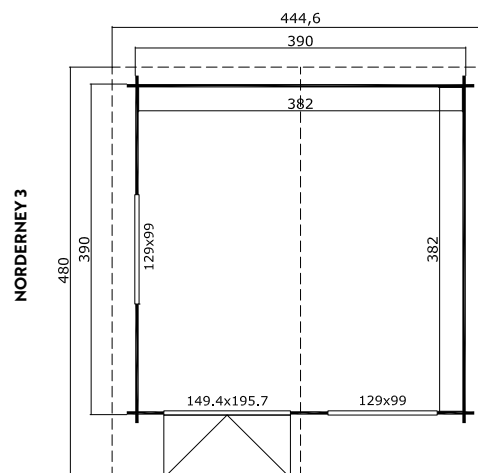
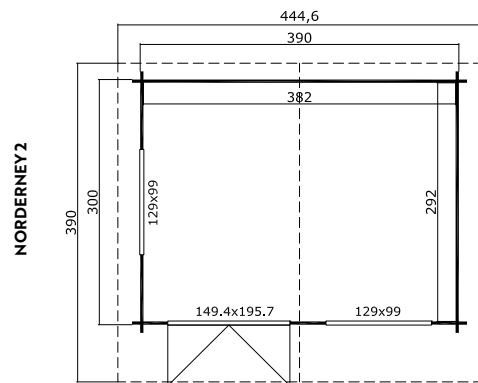



16 m²

Carroz

CARROZ BRONZE

MODERN LOOK AND NATURAL LIGHT THANKS TO FLOOR-TO-CEILING WINDOW.



CARROZ	
Item number	2850796
Base dimensions W x D	456 x 360 cm
Wall thickness	28 mm
Floor area	15.96 m ²
Capacity	35.94 m ³
Side wall height	200 cm
Ridge height	251 cm
Roof overhang	20 cm
Roof area	20.83 m ²
Double door W x H	149 x 185 cm
Single door W x H	78 x 185 cm
Single window W x H	46 x 178 cm
Floor, optional	5 x 3 / 1 x 1.5 m ²
Roofing felt, optional	2 x 15 / 1 x 10 m
Roof shingles, optional (pack)	8 x

APPROPRIATE ACCESSORIES



Standard roofing felt



Bar unit



Roof extension

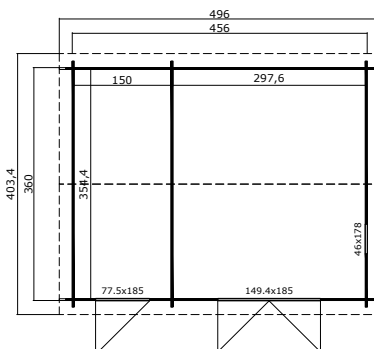

Other accessories
can be found from page 84.



WELS BRONZE

CLASSIC GARDEN CABIN FOR ANY SPACE REQUIREMENT.

	WELS 1	WELS 2	WELS 3	WELS 4 DT	WELS 5
Item number	2837400	2837500	2837600	2830400	2837700
Base dimensions W x D	200 x 200 cm	230 x 230 cm	300 x 300 cm	390 x 390 cm	510 x 400 cm
Wall thickness	28 mm	28 mm	28 mm	28 mm	28 mm
Floor area	3.78 m ²	5.04 m ²	8.67 m ²	14.78 m ²	19.89 m ²
Capacity	8.29 m ³	11.05 m ³	19.02 m ³	32.43 m ³	43.66 m ³
Side wall height	194 cm	194 cm	194 cm	194 cm	194 cm
Ridge height	234 cm	234 cm	245 cm	245 cm	245 cm
Roof overhang	10 cm	10 cm	10 cm	10 cm	10 cm
Roof area	5.50 m ²	7 m ²	11.81 m ²	18.04 m ²	23.52 m ²
Double door W x H	77 x 185 cm	77 x 185 cm	77 x 185 cm	149 x 185 cm	149 x 185 cm
2 x Single window W x H	69 x 88 cm	69 x 88 cm	69 x 88 cm	2 x 69 x 88 cm	2 x 69 x 88 cm
Floor, included	15.5 mm	15.5 mm	15.5 mm	15.5 mm	15.5 mm
Roofing felt, optional	1 x 10 m	1 x 15 m	2 x 10 m	2 x 15 m	4 x 10 m
Roof shingles, optional (pack)	3 x	3 x	5 x	7 x	9 x

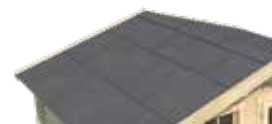

Standard roofing felt



Terrace

Other accessories
can be found from page 84.

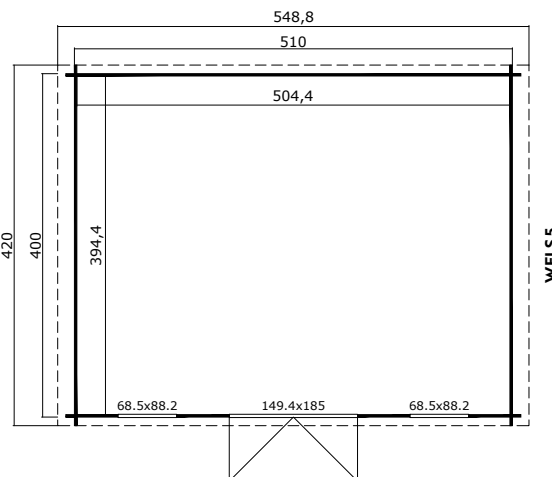
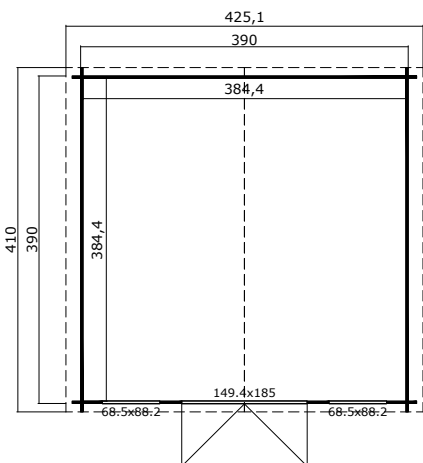
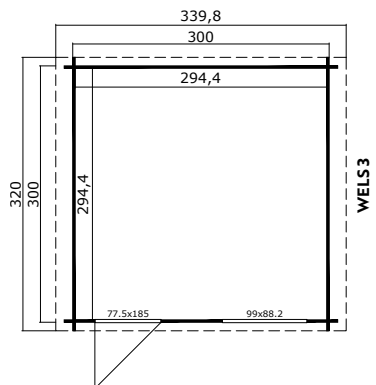
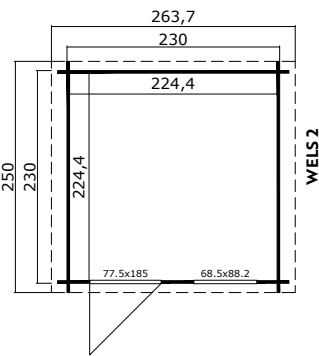
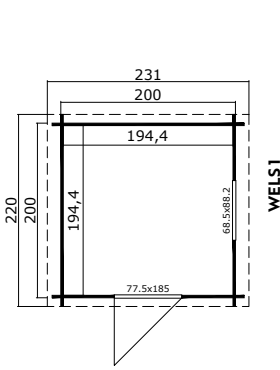



LOLA SILVER

COSY CABIN WITH COVERED SEATING AREA.



LOLA 2

Item number	2816000
Base dimensions W x D	300 x 300 cm
Wall thickness	28 mm
Floor area	8.67 m ²
Capacity	19.02 m ³
Side wall height	194 cm
Ridge height	245 cm
Roof overhang	150 cm
Roof area	16.92 m ²
Double door W x H	149 x 185 cm
2 x single window W x H	88 x 99 cm
Floor, included	18.5 mm
Roofing felt, optional	2 x 10 m
Roof shingles, optional (pack)	7 x

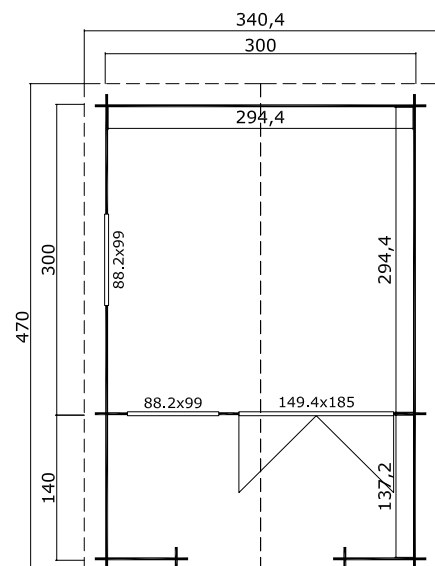



LUNA SILVER

ROMANTIC CABIN WITH LONG ROOF OVERHANG.



LUNA 2

Item number	2816200
Base dimensions W x D	360 x 360 cm
Wall thickness	28 mm
Floor area	12.56 m ²
Capacity	27.56 m ³
Side wall height	194 cm
Ridge height	245 cm
Roof overhang	150 cm
Roof area	22.26 m ²
Double door W x H	149 x 185 cm
2 x single window W x H	88 x 99 cm
Floor, included	18.5 mm
Roofing felt, optional	2 x 15 / 1 x 10 m
Roof shingles, optional (pack)	9 x

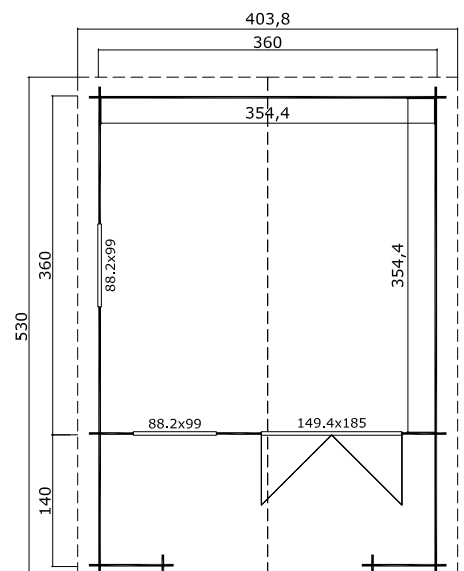



RIVERSIDE SILVER

BRIGHT, COSY CABIN WITH SMALL, COVERED TERRACE.



	RIVERSIDE
Item number	2851500
Base dimensions W x D	480 x 300 mm
Wall thickness	28 mm
Floor area	13.97 m ²
Capacity	32.24 m ³
Side wall height	211 cm
Ridge height	251 cm
Roof overhang	28.60 cm
Roof area	19.98 m ²
Glazed double door W x H	159 x 196 cm
2 x single window W x H	56 x 178 cm
Floor, included	18.5 mm
Roofing felt, optional	3 x 15 m
Roof shingles, optional (pack)	7 x

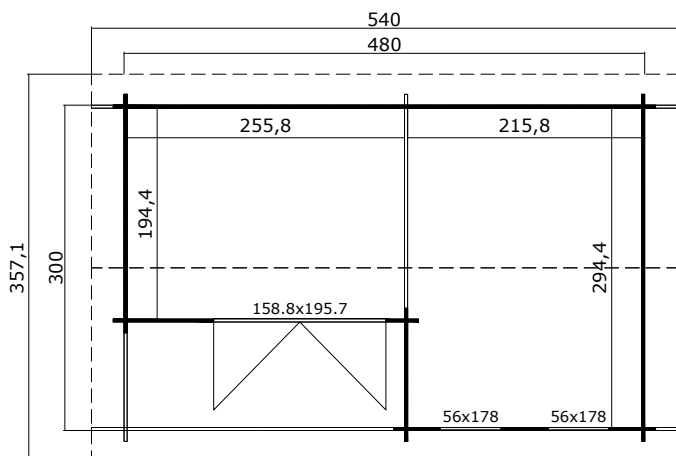



KEILA BRONZE

GARDEN CABIN WITH PRACTICAL STOREROOM.



	KEILA 28	KEILA 34
Item number	2841500	3415600
Base dimensions W x D	380 x 250 cm	425 x 280 cm
Wall thickness	28 mm	34 mm
Floor area	9.15 m ²	11.43 m ²
Capacity	20.60 m ³	26.38 m ³
Side wall height	194 cm	205.20 cm
Ridge height	257 cm	257 cm
Roof overhang	70 cm	50 cm
Roof area	15.30 m ²	17.15 m ²
Double door W x H	149 x 185 cm	149 x 185 cm
Single door W x H	78 x 185 cm	78 x 185 cm
Double window W x H	129 x 88 cm	129 x 88 cm
Floor, included	15.5 mm	15.5 mm
Roofing felt, optional	2 x 15 m	2 x 15 m
Roof shingles, optional (pack)	6 x	7 x

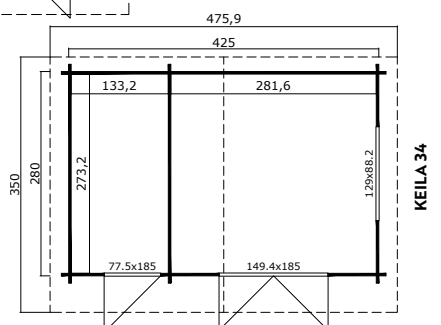
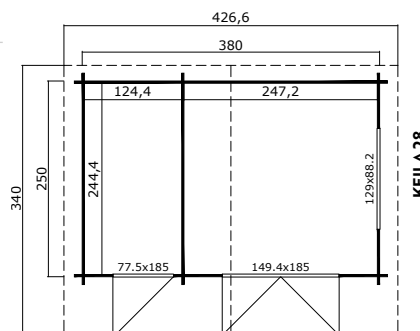



ROBIN BRONZE

LARGE WINDOW FRONTAGE FOR A LIGHT-FLOODED INTERIOR.



	ROBIN 280
Item number	2840900
Base dimensions W × D	330 × 280 cm
Wall thickness	28 mm
Floor area	8.90 m ²
Capacity	19.53 m ³
Side wall height	194 cm
Ridge height	245 cm
Roof overhang	55 cm
Roof area	14.20 m ²
Double door W × H	149 × 185 cm
2 × fixed window W × H	56 × 122 cm
Floor, included	15.5 mm
Roofing felt, optional	2 × 15 m
Roof shingles, optional (pack)	6 ×

APPROPRIATE ACCESSORIES



Standard roofing felt

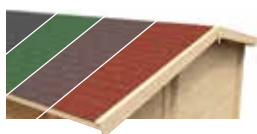

Roof shingles in various colours

Other accessories can be found from page 84.

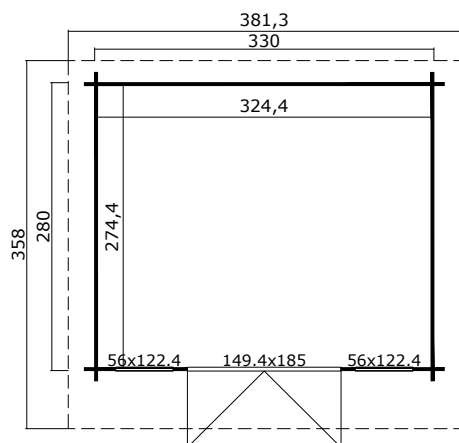



WILLIAM BRONZE

BEST OF BOTH WORLDS: STOREROOM MEETS LIVING ROOM.



	WILLIAM
Item number	2841700
Base dimensions W x D	380 x 250 cm
Wall thickness	28 mm
Floor area	9.15 m ²
Capacity	20.08 m ³
Side wall height	200 cm
Ridge height	239 cm
Roof overhang	22 cm
Roof area	13.02 m ²
Double door W x H	149 x 185 cm
Single door W x H	78 x 185 cm
2 x fixed windows W x H	90 x 32 cm
Floor, included	15.5 mm
Roofing felt, optional	2 x 10 m
Roof shingles, optional (pack)	6 x

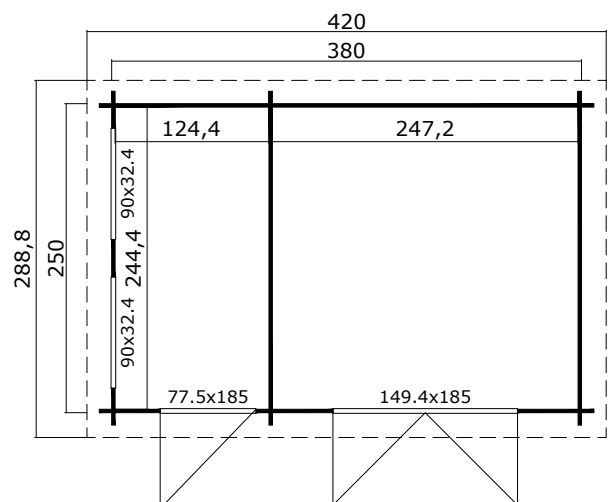



BLOCK CABINS WITH GABLE ROOF AND COVERED AREA.

**THE COSY AND STABLE OUTDOOR SEATING
AREA IN THE GARDEN – WITH PRACTICAL
STORAGE SPACE.**

09

MODELS



Great as a covered BBQ area



11 m²

Kirian 300

SAN DIEGO

KIRIAN, WIBO BRONZE

COSY, COVERED SEATING AREA, WITH OR WITHOUT STOREROOM.



	KIRIAN 300	SAN DIEGO	WIBO
Item number	2839296	3418796	2833400
Base dimensions W x D	380 x 300 cm	425 x 300 cm	425/144 x 300 cm
Wall thickness	28 mm	34 mm	28 mm
Floor area	11 m ²	12.26 m ²	12.35 m ²
Capacity	28.60 m ³	29.70 m ³	27.80 m ³
Side wall height	211 cm	211 cm	205 cm
Ridge height	274 cm	274 cm	245 cm
Roof overhang	20 cm	69.20 cm	19 cm
Roof area	17.22 m ²	19.10 m ²	16.28 m ²
Double door W x H	-	-	-
Single door W x H	-	-	78 x 185 cm
Floor	-	-	Included, 15.5 mm
Roofing felt, optional	2 x 15 m	2 x 15 m	2 x 10 m
Roof shingles, optional (pack)	7 x	7 x	7 x

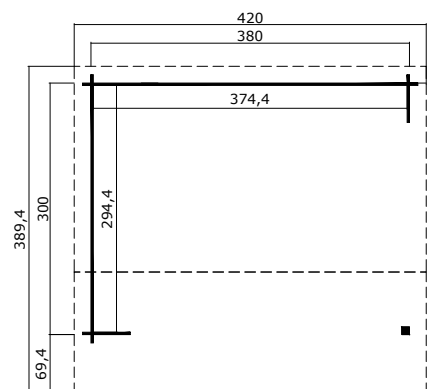

KIRIAN 300

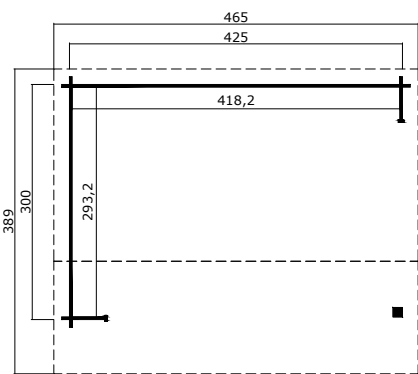

SAN DIEGO

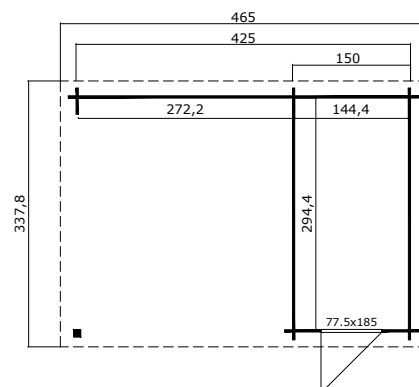

WIBO



15.2 m² Ivana



15.6 m² Kenzo

IVANA, KENZO BRONZE

GARDEN CABINS WITH LARGE OUTDOOR AREA.

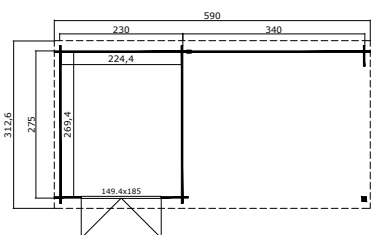

IVANA

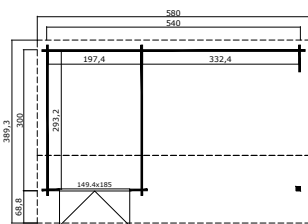

KENZO



	IVANA	KENZO
Item number	2838596	3415500
Base dimensions W × D	570/230 × 275 cm	540/197 × 300 cm
Wall thickness	28 mm	34 mm
Floor area	15.20 m ²	15.63 m ²
Capacity	32.50 m ³	40.55 m ³
Side wall height	200 cm	245 cm
Ridge height	228 cm	274 cm
Roof overhang	20 cm	70 cm
Roof area	18.88 m ²	23.78 m ²
Double door W × H	149 × 185 cm	149 × 185 cm
Floor, optional	3 × 3 / 1 × 1.5 m ²	Included, 18.5 m ²
Roofing felt, optional	2 × 15 m	3 × 15 m
Roof shingles, optional (pack)	8 ×	10 ×



19.8 m² New York



Amarillo

NEW YORK, AMARILLO SILVER PLENTY OF SPACE FOR LIVING AND LEISURE.

	NEW YORK	AMARILLO
Item number	3418996	2848196
Base dimensions W x D	680/300 x 380 cm	710/330 x 330 cm
Wall thickness	34 mm	28 mm
Floor area	19.74 m ²	22.85 m ²
Capacity	51.19 m ³	52.75 m ³
Side wall height	245 cm	211 cm
Ridge height	274 cm	251 cm
Roof overhang	68 cm	29 cm
Roof area	29.52 m ²	29.50 m ²
Double door W x H	149 x 196 cm	149 x 196 cm
Floor, optional	3 x 3 m ²	4 x 3 m ²
Roofing felt, optional	2 x 15 / 1 x 10 m	2 x 15 / 1 x 10 m
Roof shingles, optional (pack)	7 x	12 x

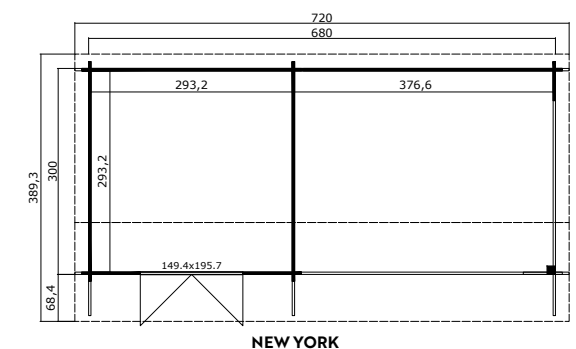

NEW YORK

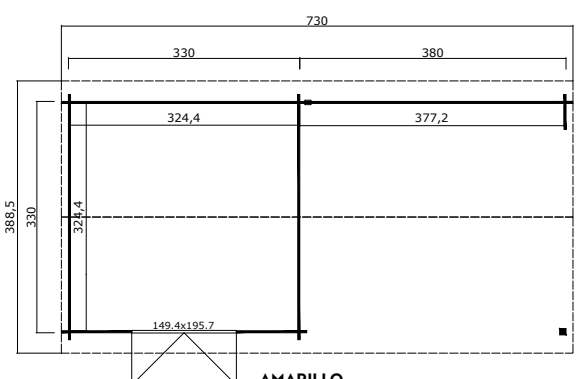

AMARILLO



BLOCK CABINS WITH FLAT ROOF.

MODERN GARDEN CABINS
FOR MODERN GARDENS

08

MODELS





BELMONT BRONZE

MODERN, BRIGHT CABIN WITH PRACTICAL STOREROOM.



	BELMONT 1	BELMONT 2
Item number	2837800	3414200
Base dimensions W × D	380 × 250 cm	425 × 280 cm
Wall thickness	28 mm	34 mm
Floor area	9.15 m ²	11.43 m ²
Capacity	19.30 m ³	24.10 m ³
Side wall height	200 cm	200 cm
Ridge height	222 cm	222 cm
Roof overhang	20 cm	20 cm
Roof area	12.18 m ²	14.88 m ²
Double door W x H	149 × 185 cm	149 × 185 cm
Single door W x H	77 × 185 cm	78 × 185 cm
Floor, included	15.5 mm	15.5 mm
Roofing felt, optional	2 × 10 m	2 × 10 m
Onduline, optional	4 ×	4 ×

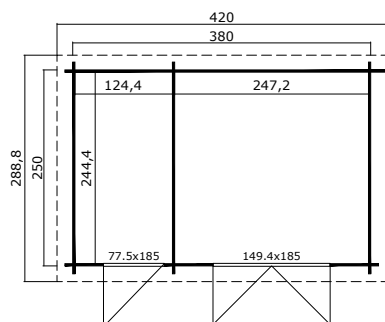

BELMONT 1

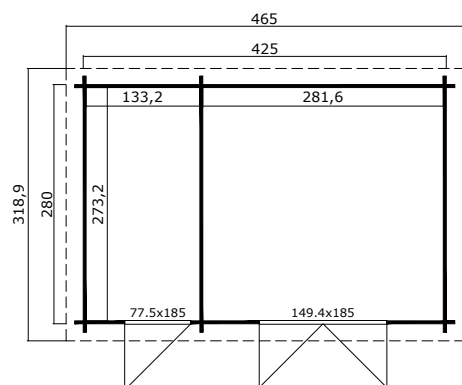

BELMONT 2



5 m²
Indi 230

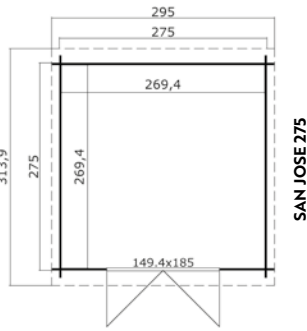
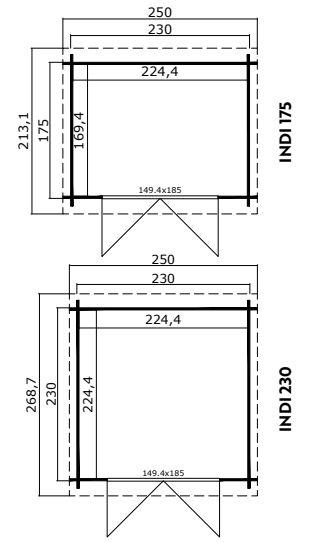

7,26 m²

INDI BRONZE
SAN JOSE
COSY BRIGHT
EQUIPMENT STORE.

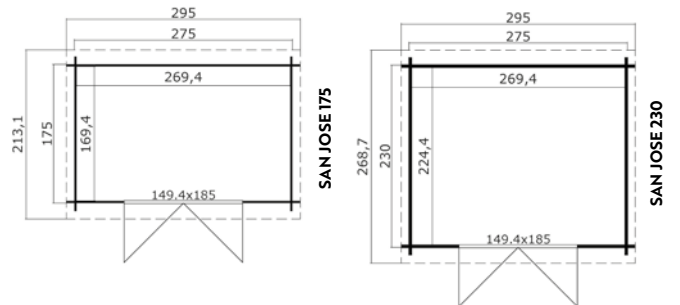

	INDI 175	INDI 230	SAN JOSE 175	SAN JOSE 230	SAN JOSE 275
Item number	2834096	2834196	2835596	2835696	2835796
Base dimensions W x D	230 x 175 cm	230 x 230 cm	275 x 175 cm	275 x 230 cm	275 x 275 cm
Wall thickness	28 mm	28 mm	28 mm	28 mm	28 mm
Floor area	3.80 m ²	5.04 m ²	4,56 m ²	6,05 m ²	7,26 m ²
Capacity	7.58 m ³	10.05 m ³	9,10 m ³	14,48 m ³	12,06 m ³
Side wall height	188 cm	188 cm	188 cm	188 cm	188 cm
Ridge height	211 cm	211 cm	211 cm	211 cm	211 cm
Roof overhang	20 cm	20 cm	20 cm	20 cm	20 cm
Roof area	4.19 m ²	6.75 m ²	4,58 m ²	7,25 m ²	9,89 m ²
Double door W x H	149 x 185 cm	149 x 185 cm	149 x 185 cm	149 x 185 cm	149 x 185 cm
Floor, optional	1 x 3 / 1 x 1,5 m ²	2 x 3 m ²	3 x 3 / 1 x 1,5 m ²	2 x 3 / 1 x 1,5 m ²	2 x 3 / 1 x 1,5 m ²
Roofing felt, optional	1 x 10 m	1 x 10 m	1 x 10 m	1 x 15 m	1 x 15 m
Onduline, optional	3 x	3 x	3 x	3 x	4 x



6.4 m²

ATLANTA BRONZE

PRACTICAL BRIGHT CABINS FOR SMALL GARDENS.



	ATLANTA
Item number	2824796
Base dimensions W x D	292 x 230 cm
Wall thickness	28 mm
Floor area	6.43 m ²
Capacity	12.82 m ³
Side wall height	188 cm
Ridge height	211 cm
Roof overhang	10 cm
Roof area	8.11 m ²
Double door W x H	149 x 185 cm
Floor, optional	2 x 3 / 1 x 1.5 m ²
Roofing felt, optional	1 x 10 m
Onduline, optional	3 x

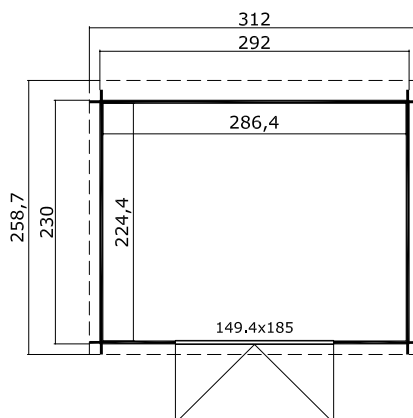



SACRAMENTO BRONZE

SMALL PENT ROOF CABIN WITH MODERN DOOR DESIGN.



SACRAMENTO

Item number	2859296
Base dimensions W x D	292 x 292 cm
Wall thickness	28 mm
Floor area	8.20 m ²
Capacity	16.36 m ³
Side wall height	188 cm
Ridge height	211 cm
Roof overhang	10 cm
Roof area	9.98 m ²
Double door W x H	149 x 185 cm
Floor, optional	3 x 3 m ²
Roofing felt, optional	1 x 15 m
Onduline, optional	4 x

APPROPRIATE ACCESSORIES

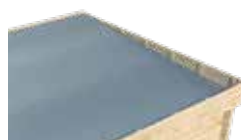

Onduline



Gutter

Other accessories can be found from page 84.

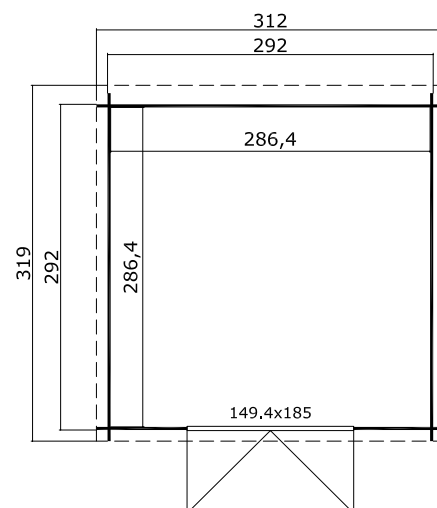



Amira 230 now also available with brown impregnation!

10.1 m²

Amira 275



AMIRA BRONZE

SPACIOUS, COMPACT AND COSY.



	AMIRA 175	AMIRA 230	AMIRA 275
Item number	2850096	2836896	2836996
Base dimensions W × D	380 × 175 cm	380 × 230 cm	380 × 275 cm
Wall thickness	28 mm	28 mm	28 mm
Floor area	6.34 m ²	8.40 m ²	10.09 m ²
Capacity	12.65 m ³	16.76 m ³	20.12 m ³
Side wall height	188 cm	188 cm	188 cm
Ridge height	211 cm	211 cm	211 cm
Roof overhang	20 cm	20 cm	20 cm
Roof area	8.70 m ²	10.80 m ²	12.60 m ²
Double door W x H	149 × 185 cm	149 × 185 cm	149 × 185 cm
Single window W x H	69 × 88 cm	69 × 88 cm	69 × 88 cm
Floor, optional	2 × 3 / 1 × 1.5 m ²	3 × 3 m ²	3 × 3 / 1 × 1.5 m ²
Roofing felt, optional	1 × 15 m	1 × 15 m	2 × 10 m
Onduline, optional	3 ×	3 ×	4 ×

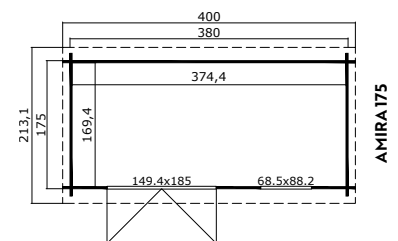

AMIRA 175

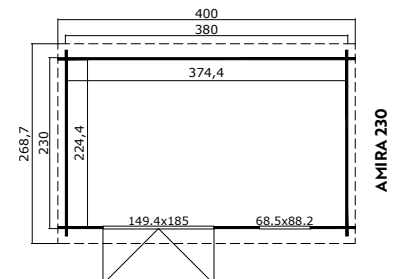

AMIRA 230

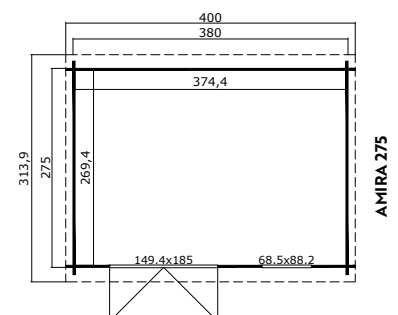

AMIRA 275



AUGUSTA SILVER

THE SMALL, BRIGHT LIVING ROOM IN THE GARDEN.



AUGUSTA

Item number	2847896
Base dimensions W x D	380 x 230 cm
Wall thickness	28 mm
Floor area	8.40 m ²
Capacity	17.96 m ³
Side wall height	211 cm
Ridge height	217 cm
Roof overhang	10 cm
Roof area	10.30 m ²
Double door W x H	159 x 196 cm
Single window W x H	90 x 32 cm
Floor, optional	3 x 3 m ²
Roofing felt, optional	1 x 15 m
Onduline, optional	3 x

APPROPRIATE ACCESSORIES



Skylight



Onduline

Other accessories can be found from page 84.

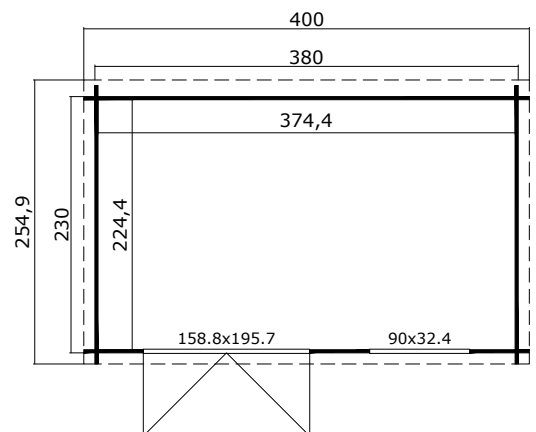

BLOCK CABINS WITH FLAT ROOF AND COVERED AREA.

A MODERN SEATING AREA IN THE GARDEN
WITH PRACTICAL STOREROOM
NEXT TO IT.

11

MODELS

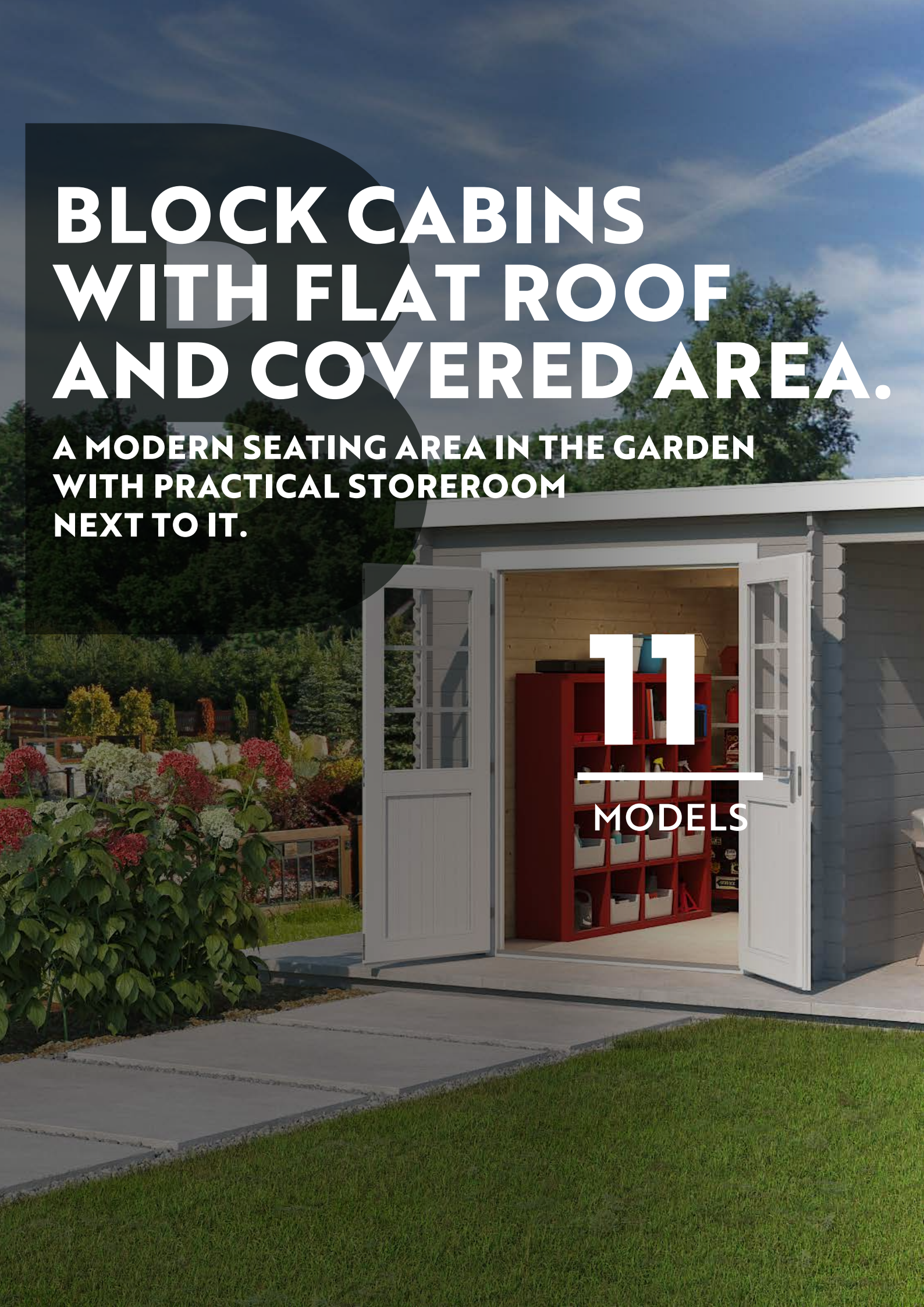





6.5 m²

Jelle Plus

JELLE PLUS BRONZE

PENT ROOF CABIN WITH MODERN ALLGLASS DOOR AND LARGE OUTDOOR AREA.



JELLE PLUS

Item number	2839196
Base dimensions W x D	370/175 x 175 cm
Wall thickness	28 mm
Floor area	6.48 m ²
Capacity	5.72 m ³
Side wall height	188 cm
Ridge height	211 cm
Roof overhang	20 cm
Roof area	8.38 m ²
Single door W x H	77 x 185 cm
Floor, optional	1 x 3 m ²
Roofing felt, optional	1 x 15 m
Onduline, optional	3 x

APPROPRIATE ACCESSORIES

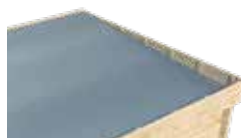

Onduline



Side panel
in various colours

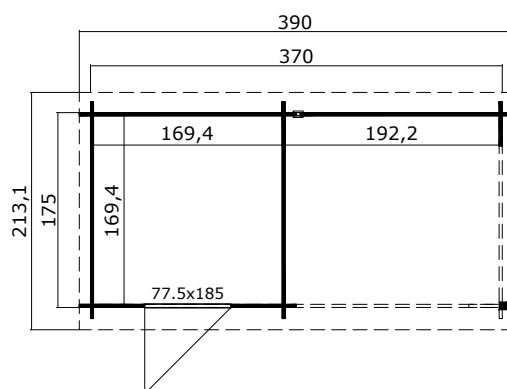

Other accessories
can be found from page 84.



LONG BEACH BRONZE

SMALL, BRIGHT ROOM WITH PLENTY OF SPACE FOR FUN.



LONG BEACH

Item number	2845196
Base dimensions W x D	472/194 x 230 cm
Wall thickness	28 mm
Floor area	10.47 m ²
Capacity	22.38 m ³
Side wall height	211 cm
Ridge height	217 cm
Roof overhang	10 cm
Roof area	12.60 m ²
Double door W x H	149 x 185 cm
Floor, optional	2 x 3 / 1 x 1.5 m ²
Roofing felt, optional	1 x 15 / 1 x 10 m
Onduline, optional	4 x

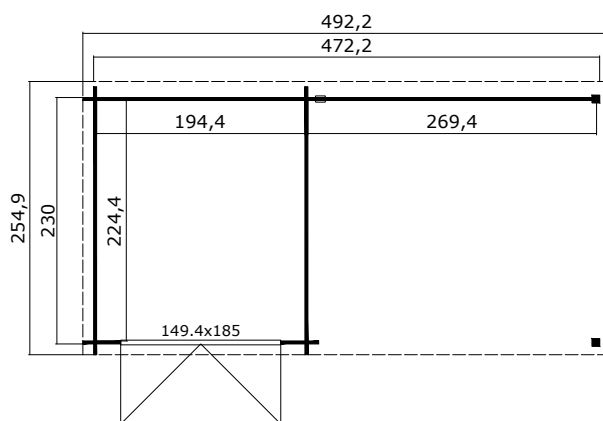



22.3 m²

New Orleans



16 m²

Novia Plus

NEW ORLEANS SILVER

NOVIA PLUS BRONZE

**MODERN ALL-GLASS
DOOR AND PLENTY OF
SPACE FOR RELAXATION.**

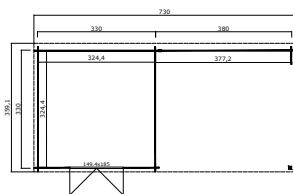

NEW ORLEANS

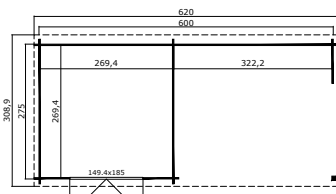

NOVIA PLUS

	NEW ORLEANS	NOVIA PLUS
Item number	2848296	2839996
Base dimensions W x D	710/330 x 330 cm	600/275 x 275 cm
Wall thickness	28 mm	28 mm
Floor area	22.85 m ²	16.01 m ²
Capacity	48.84 m ³	31.95 m ³
Side wall height	199 cm	188 cm
Ridge height	222 cm	211 cm
Roof overhang	10 cm	15 cm
Roof area	26.50 m ²	19.22 m ²
Double door W x H	159 x 196 cm	149 x 185 cm
Floor, optional	4 x 3 m ²	3 x 3 m ²
Roofing felt, optional	2 x 15 m	2 x 15 m
Onduline, optional	8 x	6 x

**KIT FOR NOVIA PLUS
SIMPLY MOVE THE
ENTRANCE DOOR**

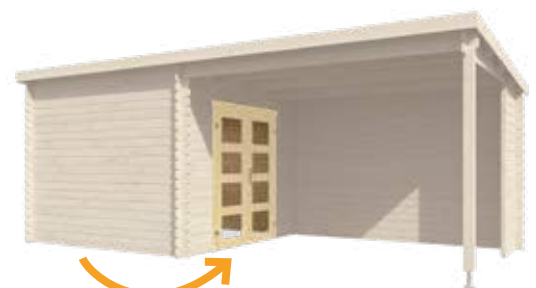

NOVIA PLUS DOOR KIT

Item number 9914800



Tampa

Saint Paul



Saint Paul

APPROPRIATE ACCESSORIES



TAMPA BRONZE

SAINT PAUL SILVER

EQUIPMENT STORE WITH LARGE COVERED AREA.

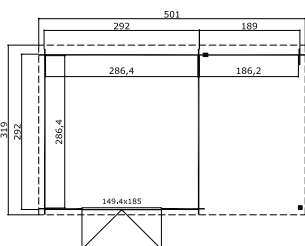

TAMPA

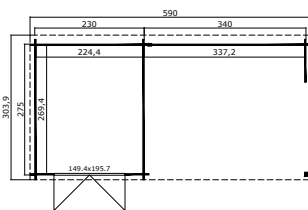

SAINT PAUL



	TAMPA	SAINT PAUL
Item number	2825096	2847696
Base dimensions W x D	481/292 x 292 cm	570/230 x 275 cm
Wall thickness	28 mm	28 mm
Floor area	14.04 m ²	15.74 m ²
Capacity	16.36 m ³	33.20 m ³
Side wall height	188 cm	200 cm
Ridge height	211 cm	222 cm
Roof overhang	10 cm	10 cm
Roof area	16.03 m ²	18.10 m ²
Double door W x H	149 x 185 cm	149 x 196 cm
Floor, optional	3 x 3 m ²	2 x 3 / 1 x 1.5 m ²
Roofing felt, optional	2 x 15 m	2 x 15 m
Onduline, optional	5 x	6 x



19.9 m²

St. Louis

ST. LOUIS BRONZE SPACIOUS OUTDOOR SEATING AREA PERFECT FOR LARGE GROUPS.

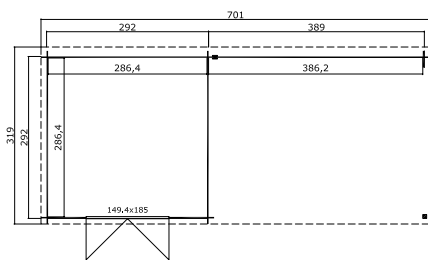

ST. LOUIS



	ST. LOUIS
Item number	2824696
Base dimensions W x D	681/292 x 292 cm
Wall thickness	28 mm
Floor area	19.88 m ²
Capacity	16.36 m ³
Side wall height	188 cm
Ridge height	211 cm
Roof overhang	10 cm
Roof area	22.43 m ²
Double door W x H	149 x 185 cm
Floor, optional	3 x 3 m ²
Roofing felt, optional	2 x 15 m
Onduline, optional	6 x

KIT FOR ST. LOUIS SIMPLY MOVE THE ENTRANCE DOOR



ST. LOUIS DOOR KIT

Artikelnummer 9914700



	RENO
Item number	2831796
Base dimensions W x D	760/380 x 275 cm
Wall thickness	28 mm
Floor area	20.32 m ²
Capacity	40.55 m ³
Ridge height	211 cm
Side roof	380 cm
Roof overhang	20 cm
Roof area	24.60 m ²
Double door W x H	149 x 185 cm
Single window W x H	69 x 88 cm
Floor, optional	4 x 3 / 1 x 1.5 m ²
Roofing felt, optional	4 x 10 m
Onduline, optional	8 x

RENO BRONZE

LARGE, BRIGHT ROOM WITH LOTS OF EXTRA SPACE.

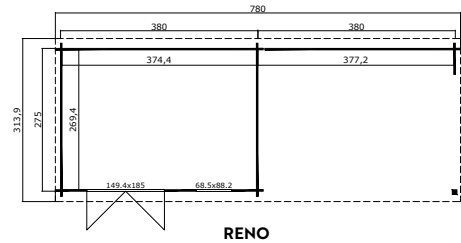



12.2 m² Columbus

COLUMBUS

BEAUTIFUL COVERED SEATING AREA FOR RELAXATION.



COLUMBUS

Item number	3418896
Base dimensions W × D	425 × 300 cm
Wall thickness	34 mm
Floor area	12.22 m ²
Capacity	29 m ³
Side wall height	222 cm
Ridge height	245 cm
Roof overhang	25 cm
Roof area	16.28 m ²
Floor, optional	–
Roofing felt, optional	2 × 10 m
Onduline, optional	4 ×

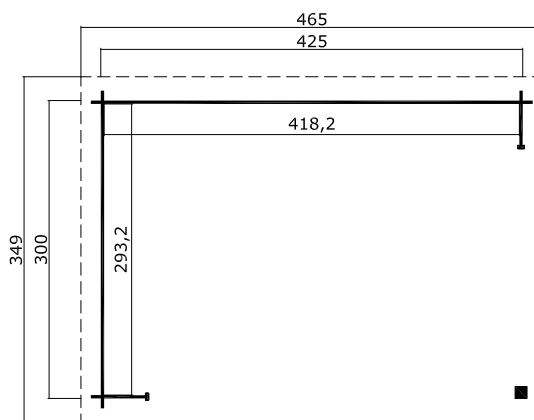

COLUMBUS

APPROPRIATE ACCESSORIES

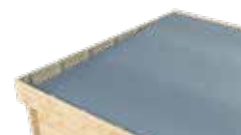

Onduline



Gutter

Other accessories can be found from page 84.



10.1 m² Buffalo 380



Buffalo 275

BUFFALO MODERN OUTDOOR SEATING FOR BALMY SUMMER NIGHTS.



	BUFFALO 275	BUFFALO 380
Item number	2850496	2847296
Base dimensions W × D	275 × 275 cm	380 × 275 cm
Wall thickness	28 mm	28 mm
Floor area	7.45 m ²	10.09 m ²
Capacity	16.96 m ³	23.86 m ³
Side wall height	222 cm	222 cm
Ridge height	245 cm	251 cm
Roof overhang	24 cm	25 cm
Roof area	10.20 m ²	13.65 m ²
Floor, optional	–	–
Roofing felt, optional	1 × 15 m	2 × 10 m
Onduline, optional	4 ×	4 ×

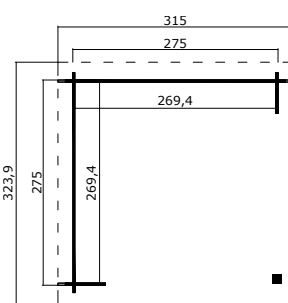

BUFFALO 275

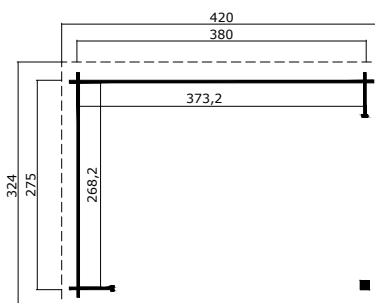

BUFFALO 380

SPECIAL GARDEN CABINS.

FOR SPECIAL REQUIREMENTS OR TASTES.
OUR SPECIALISTS.

03

MODELS



JURA BRONZE

IDEAL AS LEAN-TO OR FREESTANDING.



	JURA 2
Item number	2827596
Base dimensions W x D	180 x 275 cm
Wall thickness	28 mm
Floor area	4.70 m ²
Capacity	10.85 m ³
Side wall height	194 cm
Ridge height	268 cm
Roof overhang	10 cm
Roof area	6.78 m ²
Single door W x H	77 x 185 cm
Single window W x H	82 x 54 cm
Floor, optional	2 x 3 m ²
Roofing felt, optional	1 x 10 m
Roof shingles, optional (pack)	3 x
Onduline, optional	3 x

APPROPRIATE ACCESSORIES



Standard roofing felt

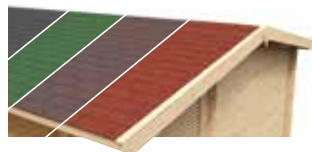

Roof shingles in various colours

Other accessories can be found from page 84.

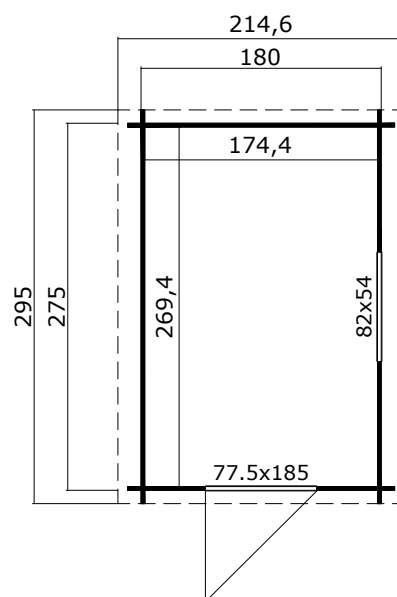



VILANO 1, VILANO 2 BRONZE

NATURAL GARDEN CABIN WITH SEPARATE STOREROOM.



	VILANO 1	VILANO 2
Item number	1911600	2856900
Base dimensions W x D	200 x 200 cm	220 x 220 cm
Wall thickness	19 mm	19 mm
Floor area	5.03 m ²	5.93 m ²
Capacity	10.60 m ³	12.50 m ³
Side wall height	193.8 cm	193.8 cm
Ridge height	228 cm	228 cm
Roof overhang	30 cm	50 cm
Roof area	11.4 m ²	11.93 m ²
Double door W x H	125 x 178 cm/ 125 x 149 cm	125 x 178 cm/ 125 x 149 cm
Floor, included	15.5 mm	15.5 mm
Roofing felt, optional	2 x 10 m	2 x 10 m
Roof shingles, optional (pack)	4 x	4 x

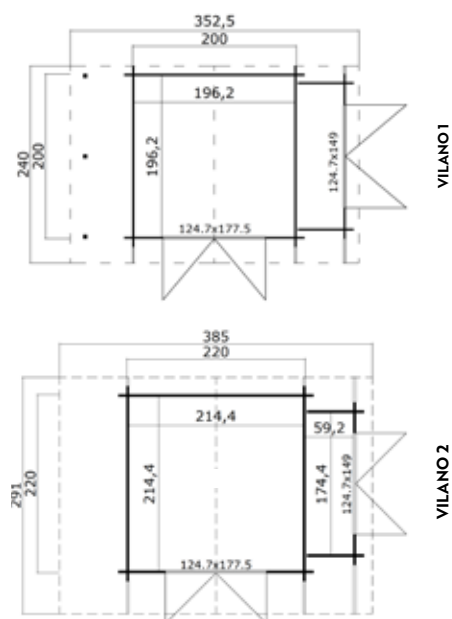



5m² Vilano 3

VILANO 3 BRONZE

VERSATILE GARDEN SHED WITH CHARM AND FUNCTION



VILANO 3	
Item number	199700
Base dimensions W x D	260 x 200 cm
Wall thickness	19 mm
Floor area	5.03 m ²
Capacity	9.74 m ³
Side wall height	182.40 cm
Ridge height	205.2 cm
Roof overhang	21 cm
Roof area	7.99 m ²
Double door W x H	125 x 178 cm/ 125 x 149 cm
Floor, included	15.5 mm
Roofing felt, optional	1 x 15 m
Roof shingles, optional (pack)	3 x
Onduline, optional	4 x

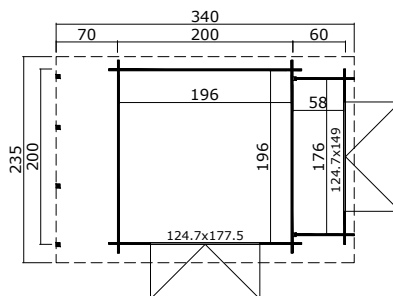

APPROPRIATE ACCESSORIES



Standard roofing felt

Roof shingles in various colours

Other accessories can be found from page 84.



GARAGES.

THE SECURE HOME FOR A CAR.

03

MODELS

NEW!



16.3 m² Mauritius

MAURITIUS BRONZE

NEW!

THE PRACTICAL GARAGE FOR A CAR.



MAURITIUS	
Item number	3422196
Base dimensions W x D	330 x 510 cm
Wall thickness	34 mm
Floor area	16.26 m ²
Capacity	38.47 m ³
Side wall height	211 cm
Ridge height	262 cm
Roof overhang	30 cm
Roof area	22.40 m ²
Double door W x H	239 x 202 cm
Roofing felt, optional	2 x 15 / 1 x 10 m
Roof shingles, optional (pack)	9 x

APPROPRIATE ACCESSORIES



Premium roofing felt

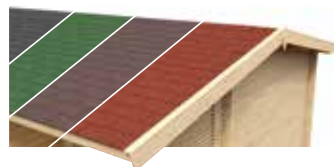

Roof shingles in various colours

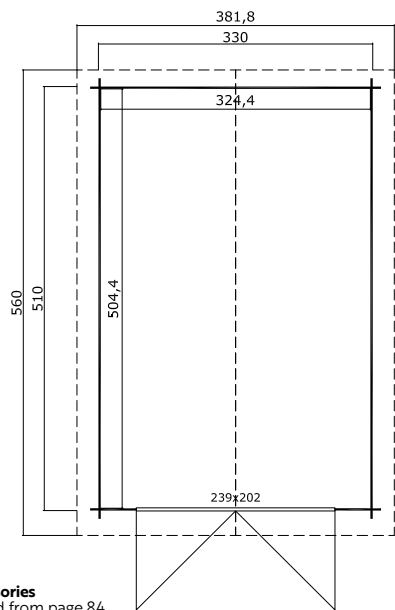

Other accessories can be found from page 84.



15.6 m²

Dillon

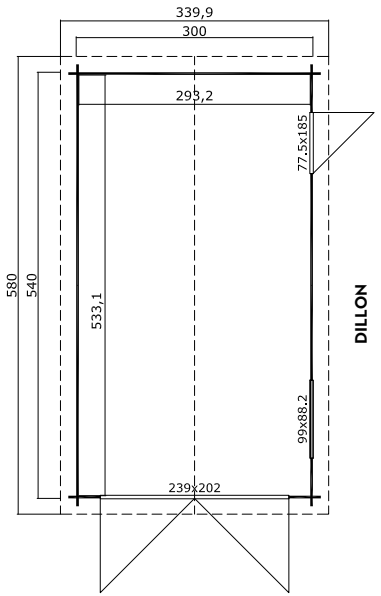

DILLON

DILLON, YARIK WITH SIDE DOOR AND LARGE WINDOW.

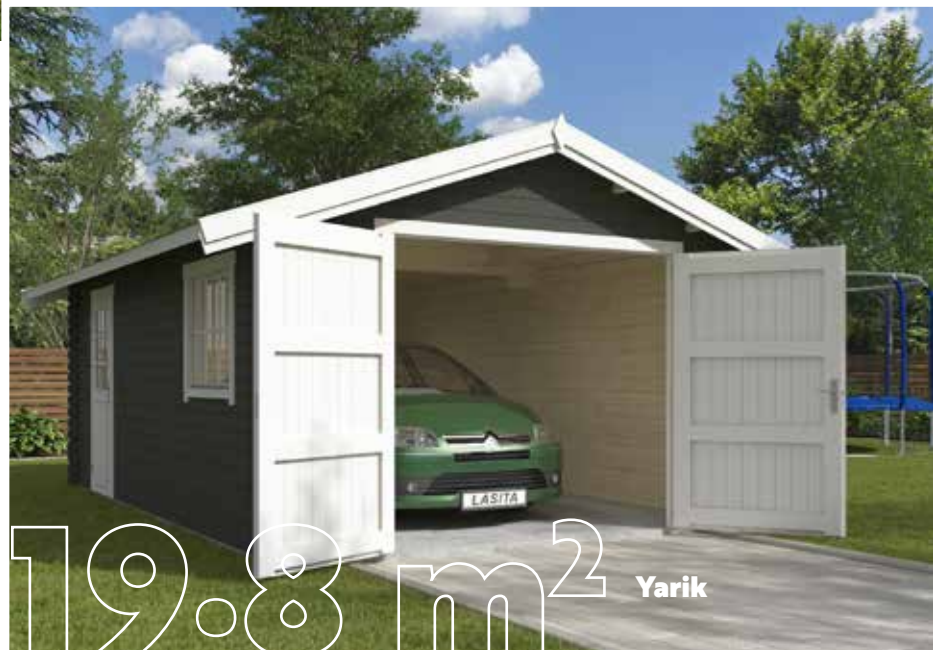

19.8 m²

Yarik



	DILLON	YARIK
Item number	3415496	4015896
Base dimensions W × D	300 × 540 cm	380 × 540 cm
Wall thickness	34 mm	40 mm
Floor area	15.63 m ²	19.79 m ²
Capacity	37.87 m ³	47.94 m ³
Side wall height	211 cm	211 cm
Ridge height	274 cm	274 cm
Roof overhang	20 cm	20 cm
Roof area	21.46 m ²	29 m ²
Wood garage door W x H	239 × 202 cm	239 × 202 cm
Single door W x H	78 × 185 cm	78 × 185 cm
Single window W x H	99 × 88 cm	99 × 88 cm
Roofing felt, optional	3 × 15 m	3 × 15 m
Roof shingles, optional (pack)	9 ×	11 ×

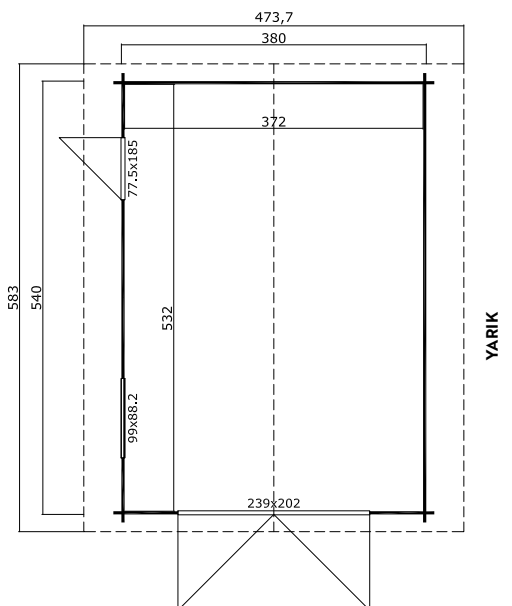

YARIK



ACCESSORIES.

FOR LOG CABINS.
INDIVIDUALLY ADAPTED TO
YOUR WANTS AND NEEDS.

28

OPTIONS



DOORS

STANDARD SINGLE DOOR



	STANDARD SINGLE DOOR
Size	835 × 1957 mm
Wood type	Spruce
Item number	UK.2.056.TSVP. MM SGC
Suitable wall thickness	28 / 34 / 40 / 44 mm
Glued wood	+
Mullions	+
Glazing	Single
Glass thickness	4 mm
U-value	5.6 W/m ² K
Silicone seal	-
Water drip	-
Opens	Exterior

MODERN SINGLE DOOR



	MODERN SINGLE DOOR
Size	835 × 1957 mm
Wood type	Spruce
Item number	UK.3.030. TMVP.MM MGC
Suitable wall thickness	28 / 34 / 40 / 44 mm
Glued wood	+
Mullions	-
Glazing	Single (frosted glass)
Glass thickness	4 mm
U-value	5.6 W/m ² K
Silicone seal	-
Water drip	-
Opens	Exterior

SOLID WOOD SINGLE DOOR



	SOLID WOOD SINGLE DOOR
Size	835 × 1975 mm
Wood type	Spruce
Item number	UL.2.100.IVP. MMW TP+
Suitable wall thickness	34 / 40 / 44 mm
Glued wood	+
Mullions	-
Glazing	-
Glass thickness	-
U-value	-
Silicone seal	-
Water drip	-
Opens	Exterior

ALL-GLASS SINGLE DOOR



	ALL-GLASS SINGLE DOOR
Size	835 × 1957 mm
Wood type	Spruce
Item number	UK.1.100.TPVP. MM DGP+
Suitable wall thickness	34 / 40 / 44 mm
Glued wood	+
Mullions	-
Glazing	Double (ISO)
Glass thickness	3 / 6 / 3 mm
U-value	3.3 W/m ² K
Silicone seal	+
Water drip	-
Opens	Exterior

STANDARD DOUBLE DOOR



ALL-GLASS DOUBLE DOOR



MODERN DOUBLE DOOR



	STANDARD DOUBLE DOOR	ALL-GLASS DOUBLE DOOR	MODERN DOUBLE DOOR
Size	1588 × 1850 mm	1494 × 1957 mm	1588 × 1975 mm
Wood type	Spruce	Spruce	Spruce
Item number	TUK.2.056.TPVP. MMW DGP+	TUK.1.108.TSVP. MMb SGC	TUK.4.020.SVP. MM SGC
Suitable wall thickness	34 / 40 / 44 mm	28 / 34 / 40 / 44 mm	28 / 34 / 40 / 44 mm
Glued wood	+	+	+
Mullions	+	+	-
Glazing	Double (ISO)	Single	Single
Glass thickness	3 / 6 / 3 mm	4 mm	4 mm
U-value	3.3 W/m ² K	5.6 W/m ² K	5.6 W/m ² K
Silicone seal	+	-	-
Water drip	-	-	-
Opens	Exterior	Exterior	Exterior

Would you like to order an extra door? No problem! Customise your garden cabin with one of our additional doors. The doors can be ordered in the appropriate thickness and with DIN left or DIN right hinges to ensure that they fit your garden cabin perfectly.

Please do not hesitate to ask your specialist dealer about options and delivery times.

WINDOW

SINGLE WINDOW 1



SINGLE WINDOW 2



SINGLE WINDOW 3



DOUBLE WINDOW



	SINGLE WINDOW 1	SINGLE WINDOW 2	SINGLE WINDOW 3	DOUBLE WINDOW
Size	685 × 882 mm	882 × 882 mm	710 × 1224 mm	1290 × 882 mm
Wood type	Spruce	Spruce	Spruce	Spruce
Item number	AK.1.106.TSSV.d SGC	AK.1.109.TPSP.b DGP+	AK.1.106.TSSP SGC	TAK.1.106.TSSP.a SGC
Suitable wall thickness	28 / 34 / 40 / 44 mm	34 / 40 / 44 mm	28 / 34 / 40 / 44 mm	28 / 34 / 40 / 44 mm
Glued wood	-	+	-	-
Mullions	+	+	+	+
Glazing	Single	Double (ISO)	Single	Single
Glass thickness	4 mm	3 / 6 / 3 mm	4 mm	4 mm
U-value	5.6 W/m ² K	3.3 W/m ² K	5.6 W/m ² K	5.6 W/m ² K
Silicone seal	-	+	-	-
Water drip	Wood	Aluminium	Wood	Wood
Opens	Interior	Interior	Interior	Interior
Opening system	2-hand tilt&turn	2-hand tilt&turn	2-hand tilt&turn	2-hand tilt&turn

MODERN SINGLE WINDOW



FLOOR-TO-CEILING SINGLE WINDOW



FLOOR-TO-CEILING DOUBLE WINDOW



SKYLIGHT (FIXED)



	MODERN SINGLE WINDOW	FLOOR-TO-CEILING SINGLE WINDOW	FLOOR-TO-CEILING DOUBLE WINDOW	SKYLIGHT (FIXED)	SKYLIGHT (FIXED) – SGC
Size	525 × 1560 mm	560 × 1780 mm	1010 × 1780 mm	1500 × 410 mm	1500 × 410 mm
Wood type	Spruce	Spruce	Spruce	Spruce	Spruce
Item number	AK.1.100.TPSP.j DGP+	AK.1.100.TPSP DGP+	TAK.1.100.TPM0.e DGP+	AK.1.100.TPM0.k DGP	AK.1.100.SM0.k SGC
Suitable wall thickness	34 / 40 / 44 mm	34 / 40 / 44 mm	34 / 40 / 44 mm	34 / 40 / 44 mm	28 / 34 / 40 / 44 mm
Glued wood	+	+	+	–	–
Mullions	–	–	–	–	–
Glazing	Double (ISO)	Double (ISO)	Double (ISO)	Double (ISO)	Single
Glass thickness	3 / 6 / 3 mm	3 / 6 / 3 mm	3 / 6 / 3 mm	3 / 6 / 3 mm	4 mm
U-value	3.3 W/m²K	3.3 W/m²K	3.3 W/m²K	3.3 W/m²K	5.6 W/m²K
Silicone seal	+	+	+	+	–
Water drip	Aluminium	Aluminium	Aluminium	Wood	–
Opens	Interior	Interior	–	–	–
Opening system	2-hand tilt&turn	2-hand tilt&turn	2-hand tilt&turn	–	–

ACCESSORIES

STANDARD ROOFING FELT



Suitable for short-term use or as underlay for other roof coverings such as shingles or premium roofing felt, available in classic grey, on a 10 m² or 15 m² roll, dimensions 1 x 10 m

	ROLL 10	ROLL 15
Item number	261	262
Floor area	10 m ²	15 m ²

PREMIUM ROOFING FELT



High-quality polymer bitumen roofing felt – suitable for long-term, waterproof covering of roofs, available in 4 colours, on 15 m² roll, dimensions 1 x 15 m

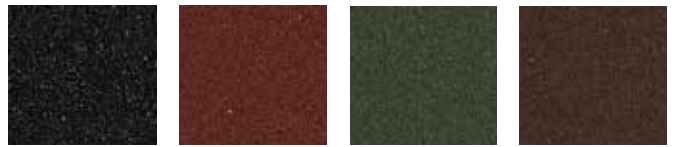

	BLACK	RED	GREEN	BROWN
Item number	37449	37451	37452	37453
Floor area	15 m ²	15 m ²	15 m ²	15 m ²

ONDULINE



ONDULINE KSK-M is a cold self-adhesive roofing membrane with an aluminium top layer and a particularly high adhesive strength. It is easy, safe and quick to apply. The aluminium top layer offers outstanding protection against UV radiation and other environmental influences. The substrate must be dry, stable, frost-free, grease-free and resistant to abrasion. Does not stick to silicone. Unevenness, holes and similar must be levelled or filled. Dimensions 500 x 100 cm

	GREY
Item number	37470
Roof area	5 m ²

ROOF SHINGLES



The 3-strip roof shingles are the most widely used roof shingles. They are easy to install and guarantee a stylish, high-quality appearance, available in the 4 most popular colours, 3 m² per pack.

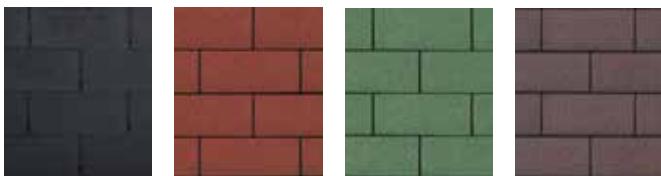

	BLACK	RED	GREEN	BROWN
Item number	263	16274	16275	264
Floor area	3 m ²	3 m ²	3 m ²	3 m ²

FLOORS



	1.5 m ²	3 m ²
Item number	2827900	2828000
Floor area	90 x 2400 mm	90 x 2400 mm
Height	18.5 mm	18.5 mm
Number	7	14

PENT ROOF



	A 90 x 240	A 90 x 300	B 90 x 240	B 90 x 300
Item number	280700	285200	9901600	9901700
Wall thickness	-	-	19 mm	19 mm
Base dimensions W x D	90 x 240 cm	90 x 300 cm	90 x 240 cm	90 x 300 cm
Floor area	2 m ²	2.50 m ²	2 m ²	2.50 m ²
Capacity	3.50 m ³	4.40 m ³	3.50 m ³	4.40 m ³
Side wall height	166 cm	166 cm	166 cm	166 cm
Ridge height	186 cm	186 cm	186 cm	186 cm
Roof area	2.60 m ²	3.30 m ²	2.60 m ²	3.30 m ²
Roof covering, optional	1 x 15 m	1 x 15 m	1 x 15 m	1 x 15 m
Roof shingles, optional (pack)	2 x	2 x	2 x	2 x

ACCESSORIES

TERRACES



	28 3013	40 3613
Item number	285300	4018600
Wall thickness	28 mm	40 mm
Base dimensions W × D	300 × 120 cm	360 × 120 cm
Floor area	3.40 m ²	3.90 m ²
Floor	Included	Included

FLOWER BOX



	FOR SINGLE WINDOWS
Item number	990600
Box width	84.6 cm
	FOR DOUBLE WINDOWS
Item number	990800
Box width	125.4 cm

BAR



	BAR UNIT
Item number	991900
Dimensions W × D	190 × 65 cm
Height	102 cm

PAINT FOR REPAINTING

If you have bought a garden cabin that has already been painted by Lasita Maja, you can obtain the original paint for repainting from a well-stocked specialist shop.



GUTTERS



Gutter sets for garden cabins with a roof depth of 490 cm. Consisting of gutter, gutter connector, gutter bracket, end pieces, rainwater downpipe, pipe elbow, downpipe bracket, diameter 10 cm.

	SET A	SET A INCL. DOWNPIPE	SET B	SET B INCL. DOWNPIPE	SET C INCL. DOWNPIPE	SET D INCL. DOWNPIPE	SET E INCL. DOWNPIPE	SET F INCL. DOWNPIPE
Item number	35807	35808	35809	35810	35811	35812	35813	35814
For roof length	180 – 219 cm	180 – 219 cm	220 – 259 cm	220 – 259 cm	260 – 300 cm	301 – 349 cm	350 – 390 cm	400 – 490 cm

WINDOW SHUTTERS



Available for single or double windows

Window shutters for windows (cm)	540 × 540	685 × 882	770 × 770	770 × 990	882 × 882	882 × 990	882 × 1110	1290 × 882
Item number	994300	994400	994500	994600	994700	994800	994900	995000

All about the garden cabin

GOOD TO KNOW.



What should I consider before ordering a garden cabin?

The assembly of a garden cabin is usually regulated by local authority regulations. Prior to ordering, enquire about the applicable regulations from your local authority. We will be happy to provide you with the relevant technical data sheets and also have static calculations available for many models.

How will my garden cabin be delivered?

We deliver our garden cabins and kits to our retail partners; on request also “free to the kerb” at your home.

Does my cabin need a foundation?

We recommend assembly on a firm foundation to which the garden cabin can also be attached. Ideally, you should create a foundation slab. This should be slightly smaller (1-2 mm/side) than the substructure.

What tools will I need for the assembly?

For correct assembly, you will need, among other things: Phillips

and possibly Torx screwdriver, cordless screwdriver, wood drill, power drill, universal pliers, Stanley knife, saw, inch rule, spirit level, string, hammer, pencil, possibly glue, possibly clamps and a ladder. At all times, when using tools, ladders etc., ensure safe handling and a secure footing. All the required screws and fittings are included in the kit.

What must I consider before assembling my garden cabin?

Read the assembly instructions and check the kit against the parts list for completeness, damage and integrity. Please note: Garden cabins and holiday homes made from wood are a natural product. Hairline cracks, gumming, knots and minor warping of the wood do not constitute grounds for complaint, as these are product-specific characteristics that do not affect the use of the product. Our blockboard assembly kits (exception: system and panel cabins) must not be screwed permanently into the walls or at the door. The boards remain “loosely” connected and must have the opportunity for flexible movement (lifting and lowering).

How can I complain about damaged parts?

Complaints are accepted if they are made in writing within 14 days of delivery of the cabin.

To do this, mark the relevant parts on the parts list and send this with the purchase receipt and assembly instructions (incl. control no.) to your dealer. They will process your complaint with us. A digital photo or presentation of the parts that you are not happy with serves as proof.

How do I ensure permanent protection of the garden cabin?

Our components are natural. Therefore, once assembled, you must paint the cabin, windows and doors on the interior and exterior with at least a colourless wood preservative. It is recommended that you use environmentally-friendly water-based products for this and refresh the protective coating at intervals of at least two years.

What form does the roofing of a garden cabin take?

If roof covering is included in the scope of delivery, we supply bitumen roofing felt for the initial covering. This should be renewed after approx. one year in order to maintain long-term rain protection. We also offer bitumen roof shingles in a high-quality and resilient form which protect the roof for a longer period of time. For our flat-roof models, we recommend our Onduline KSK-M roofing membrane as well as our gutter sets (see Accessories).

LASITA MAJA – Paint system

CARE INSTRUCTIONS.

For lasting enjoyment of your colour-stained log cabin, it is necessary to maintain the surface professionally on a regular basis. If you carry out this maintenance yourself, please read the general safety instructions in our assembly instructions and also the corresponding maintenance information. Should the surface incur minor damage during assembly or delivery, please use the paint supplied to repair this damage. This replacement paint is intended to repair small areas of mechanical damage or wood caps (spot repair) and not to paint large areas. Should you need paint for repainting, please contact your specialist dealer, they will be happy to help you.

It is important to clean the surface regularly. This will significantly extend the life of your product. Inspect your garden cabin every year for possible dirt, algae growth, damage, delamination or paint degradation. It is also important to keep the paint surface free of vegetation or plants. They prevent adequate ventilation and lead to moisture build-up. Pay particular attention to the sides facing the sun. These are exposed to more UV radiation and may need more attention.



MAINTENANCE / REPAINTING:

1. Clean the surfaces to be maintained with an appropriate cleaning agent.
2. Remove loose or porous layers of paint, preferably with a suitable abrasive material.
3. Apply the maintenance coat with a suitable brush. Ensure the paint is applied thickly and evenly.
4. Allow the paint to dry well (at least 48 h).
5. Apply a second coat to the renewed surface (attention, little paint absorption!), thereby protecting the surface.

If you carry out this maintenance correctly, you will enjoy your garden cabin for many years.

If you have any questions, please do not hesitate to contact us or your specialist dealer.

//
*NOT BEING A STRANGER
AWAY FROM HOME. NOT
HAVING TO WONDER IF
ALL THE UTENSILS WILL
BE THERE. WHAT THE BED
LINEN IS LIKE. THAT IS
WHAT A HOLIDAY MEANS
TO ME.*

**SIMPLY HOP IN THE
CAR AND ARRIVE.
AT HOME, YET AWAY.**

REQUEST A CATALOGUE NOW.

Your own holiday home is so close! Request your catalogue now featuring all the holiday homes from Lasita Maja. Over 100 pages of holiday feeling. And if the right house is not in the catalogue: with us you can also create your personal dream holiday home!

Simply request the catalogue from your specialist dealer or directly from us at www.lasita.com.

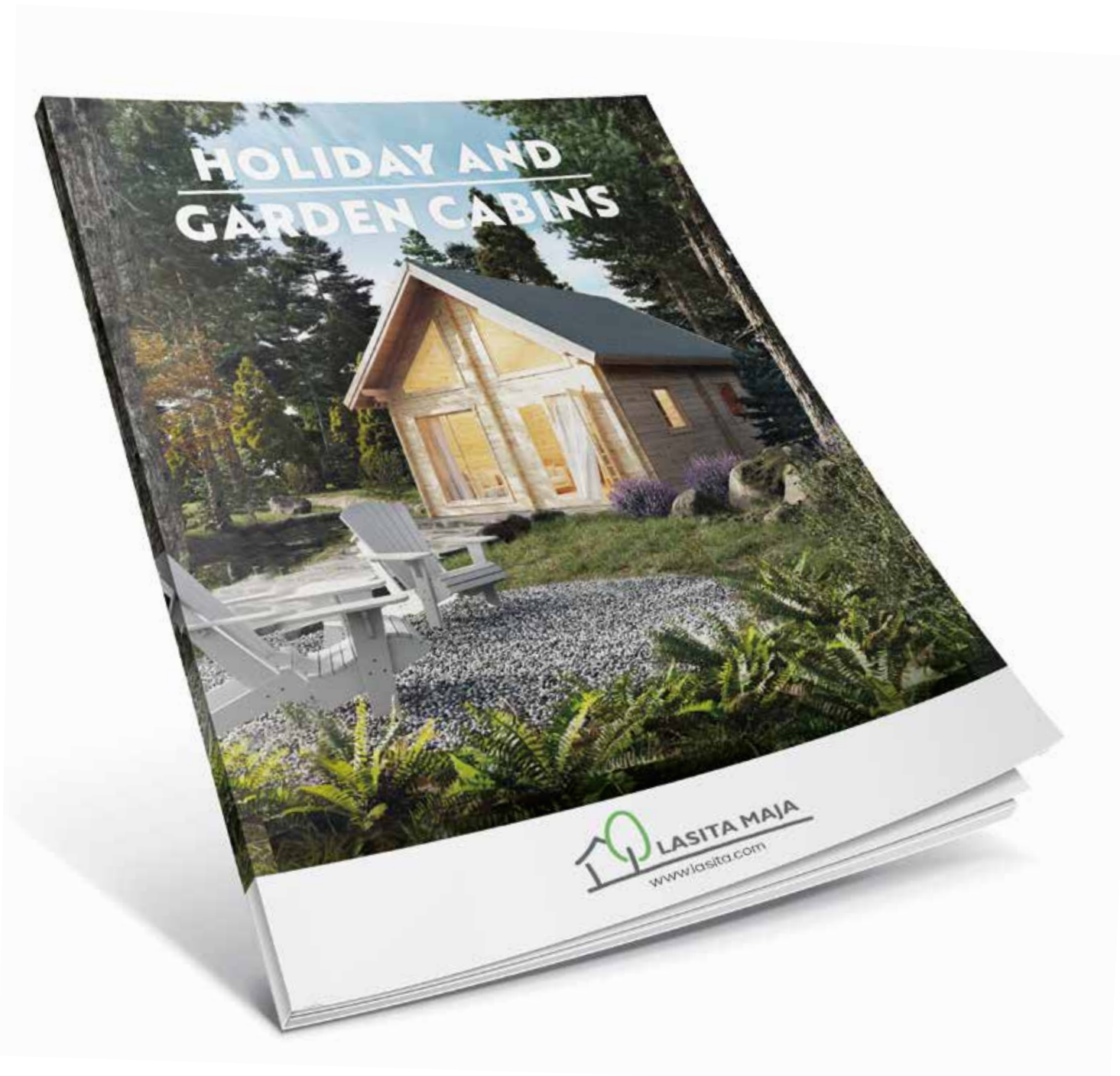

**SNAP &
WATCH**



© LASITA MAJA 2025
VERSION 01/2025 EN

The dimensions specified in the catalogue are approximate. The actual dimensions may differ slightly. Unless specified to the contrary, the products are given without accessories and without decoration. We reserve the right to make technical changes to the benefit of our products, along with small design modifications. No liability for printing errors. Item No. 50378